

Size table	S	M	L	XL
Row Spacing	650mm	700mm	750mm	800mm
		√		

Seat model optional

	SEAT PLANK	Live Load	advice	choose
--	------------	-----------	--------	--------

1	300*60*180 Aluminum alloy	2.13 kn/m ²	★★★	
---	---------------------------	------------------------	-----	--



2	291*50*2 Aluminum alloy	1.98 kn/m ²	★★★★	
---	-------------------------	------------------------	------	--

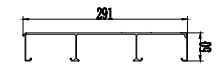

3	250*50*2 Aluminum alloy	1.77 kn/m ²	★★★★	
---	-------------------------	------------------------	------	--

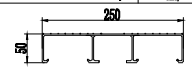

4	250*38*2 Aluminum alloy	1.61 kn/m ²	No	
---	-------------------------	------------------------	----	--

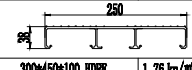

5	300*450*100 HDPE	1.76 kn/m ²	★★	
---	------------------	------------------------	----	--

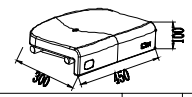

6	410*417*175 HDPE	1.76 kn/m ²	No	
---	------------------	------------------------	----	--

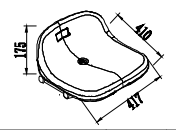

7	450*410*330 HDPE	1.76 kn/m ²	No	
---	------------------	------------------------	----	--

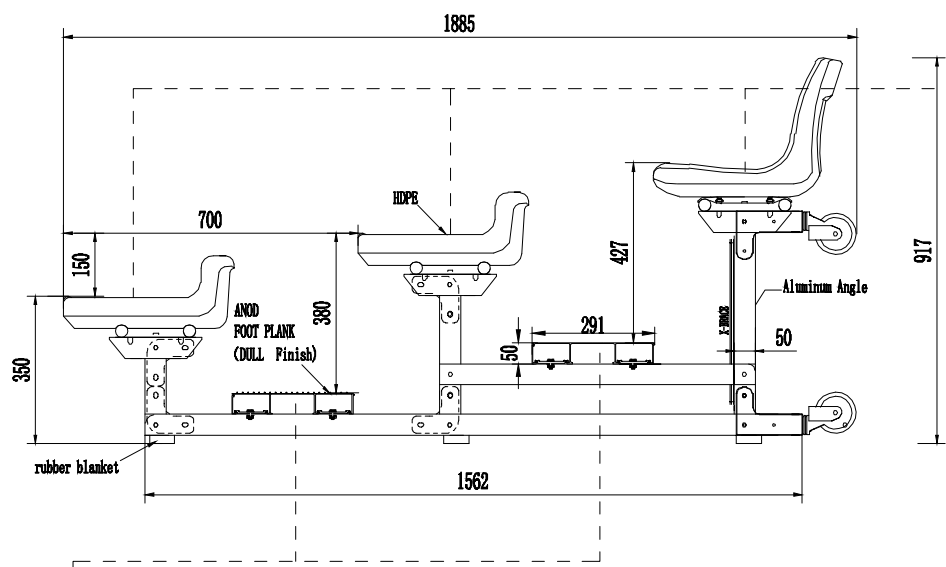
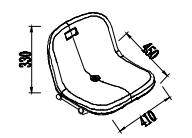

Side view AA

UNIT:mm

FOOT PLANK	1	2	3	4
	397*50*2 Aluminum alloy	291*50*2 Aluminum alloy	250*50*2 Aluminum alloy	250*38*2 Aluminum alloy
Live Load	2.81 kn/m ²	2.06 kn/m ²	1.77 kn/m ²	1.01 kn/m ²
advice	★★	★★★★	★★★★	No
choose				

Mountain bleacher

SCALE: 1:100 <http://www.mountainbleacher.com>

DATE: 2020/7/27 <http://www.mountainbleacher.com>

DESIGN: Mr. Lau Tel: 008618879222225, 008615070297138

CHECK: Mr. Cheung E-mail: dong@mountainbleacher.com

TITLE: No. 1

Size table	S	M	L	XL
Row Spacing	650mm	700mm	750mm	800mm
		√		

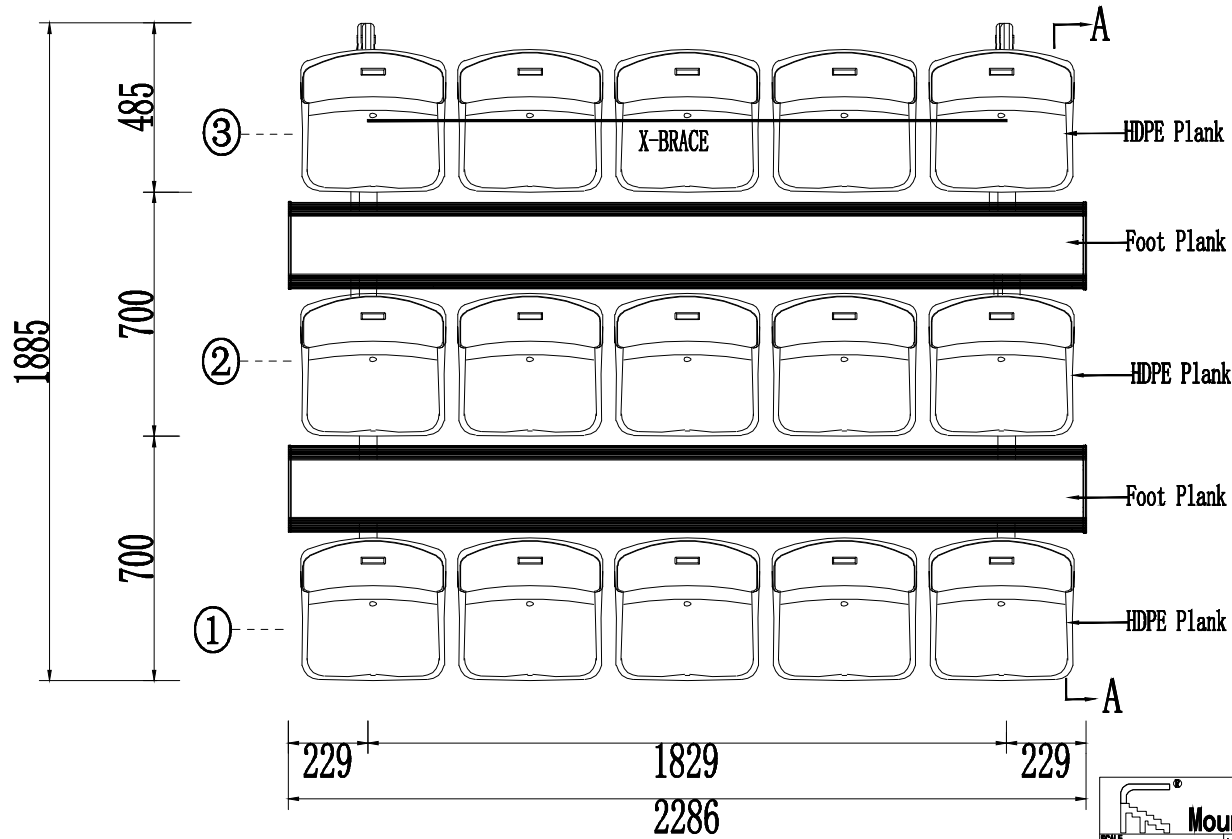

SEATING PLAN

 Mountain bleacher	
SCALE	1:100
DATE	2020/7/27
DESIGN	Mr. Len
CHECK	Mr. Chang
TITLE	
http://www.mountainbleacher.com Tel: 008615070297138 / 00861887922225 E-mail: dong@mountainbleacher.com	
NO.	1

Size table	S	M	L	XL
Row Spacing	650mm	700mm	750mm	800mm
		↓		

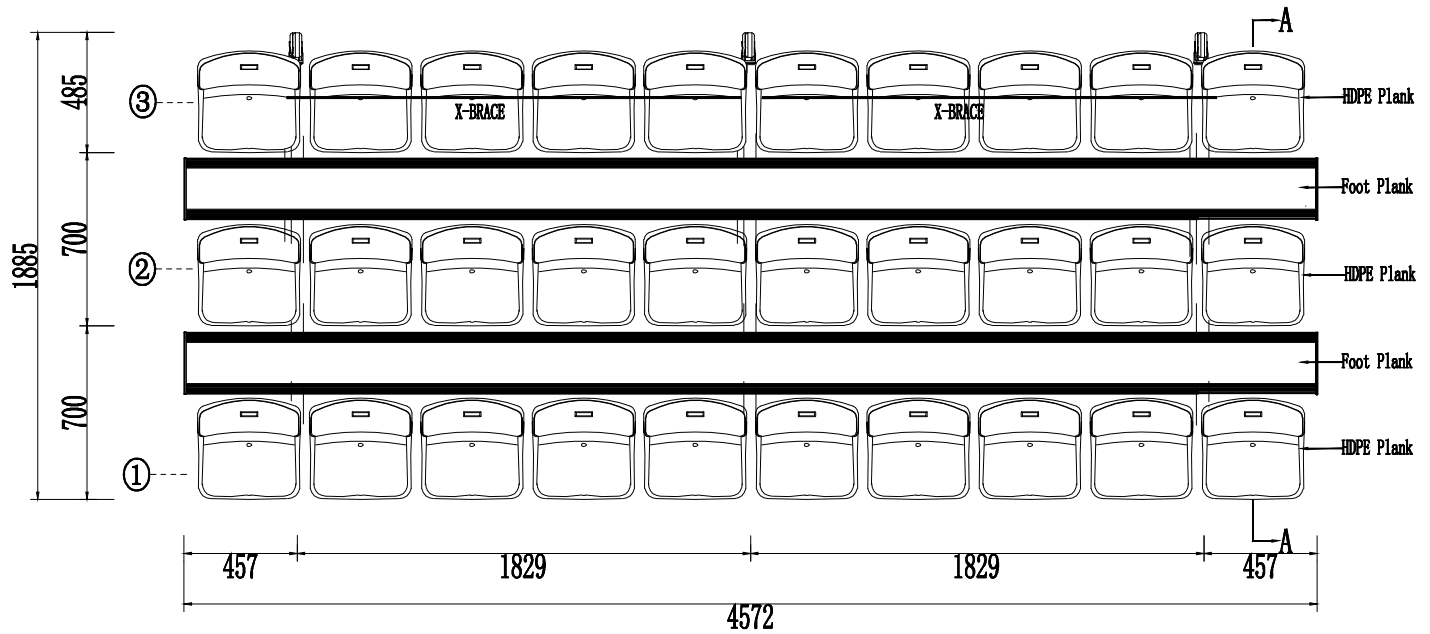

SEATING PLAN

 Mountain bleacher		
SCALE	1:100	http://www.mchair.com
DATE	2008/7/23	http://www.mountainbleacher.com
DESIGN	Mr. Lau	Tel: 008615070297138 / 008618679222226
CHECK	Mr. Cheng	E-mail: dong@mountainbleacher.com
TITLE		No. 1

Size table	S	M	L	XL
Row Spacing	650mm	700mm	750mm	800mm

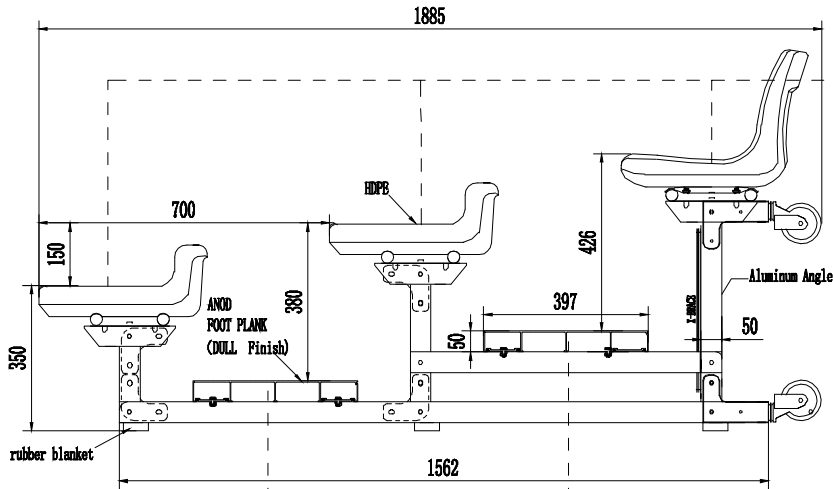

Side view AA

UNIT:mm

Seat model optional

SEAT PLANK	Live Load	advice	choose
1 300*50*100 Aluminum alloy	2.13 kn/m ²	★★★	
2 291*50*2 Aluminum alloy	1.98 kn/m ²	★★★★	
3 250*50*2 Aluminum alloy	1.77 kn/m ²	★★★★	
4 250*38*2 Aluminum alloy	1.01 kn/m ²	No	
5 300*450*100 HDPE	1.76 kn/m ²	★★	
6 410*417*176 HDPE	1.76 kn/m ²	No	
7 450*410*330 HDPE	1.76 kn/m ²	No	

FOOT PLANK	1 397*50*2 Aluminum alloy	2 291*50*2 Aluminum alloy	3 250*50*2 Aluminum alloy	4 250*38*2 Aluminum alloy
Live Load	2.81 kn/m ²	2.06 kn/m ²	1.77 kn/m ²	1.01 kn/m ²
advice	★★	★★★★	★★★★	No

Mountain bleacher

SCALE 1:100 <http://www.mchair.com>

DATE 2023/7/27 <https://www.mountainbleacher.com>

DESIGN Mr. Liu Tel:00861987722225,008615070297138

CHECK Mr. Chang E-mail:dong@mountainbleacher.com

TITLE 1

Size table	S	M	L	XL
Row Spacing	650mm	700mm	750mm	800mm
		√		

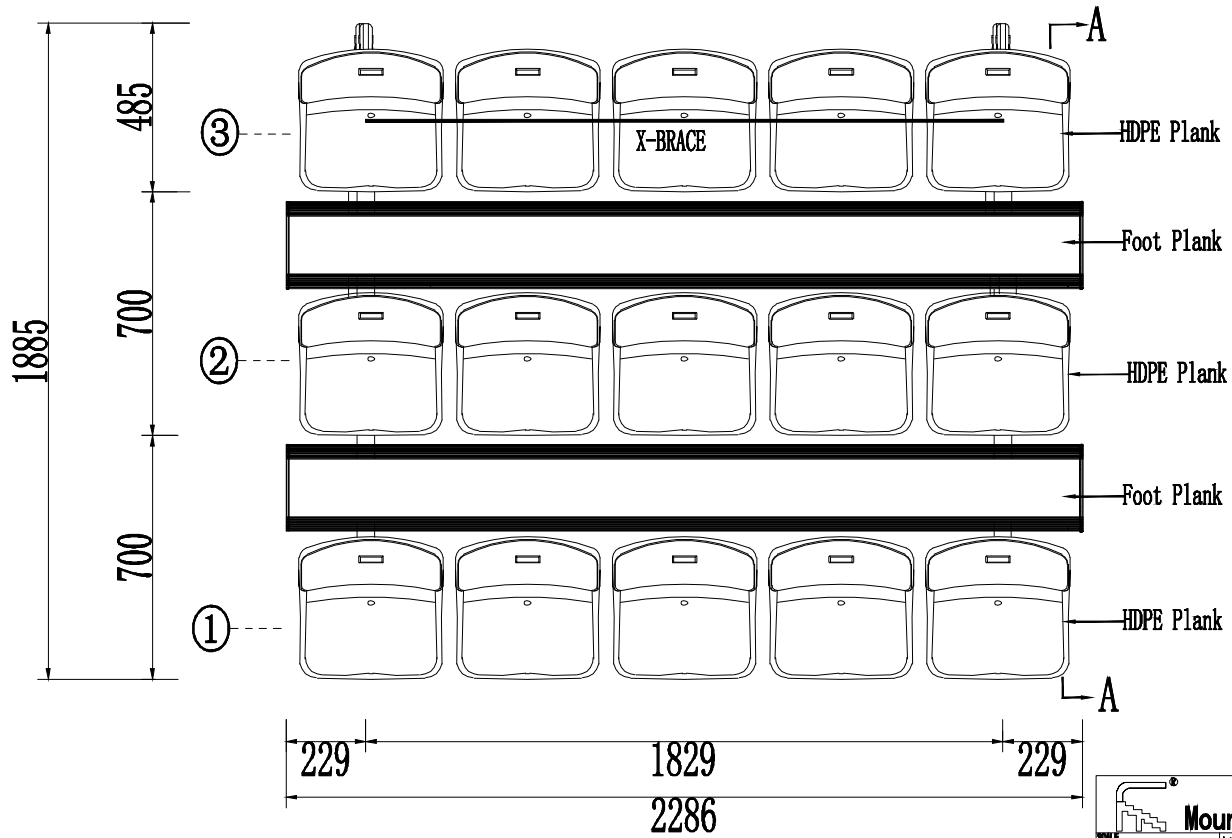

SEATING PLAN

 **Mountain bleacher**

SCALE	1:100	http://www.scochair.com
DATE	2020/7/27	https://www.mountainbleacher.com
DESIGN	Mr. Lau	Tel: 008615070297139 / 00861987922225
CHECK	Mr. Chung	E-mail: dong@mountainbleacher.com
TITLE		NO. 1

Size table	S	M	L	XL
Row Spacing	650mm	700mm	750mm	800mm
		√		

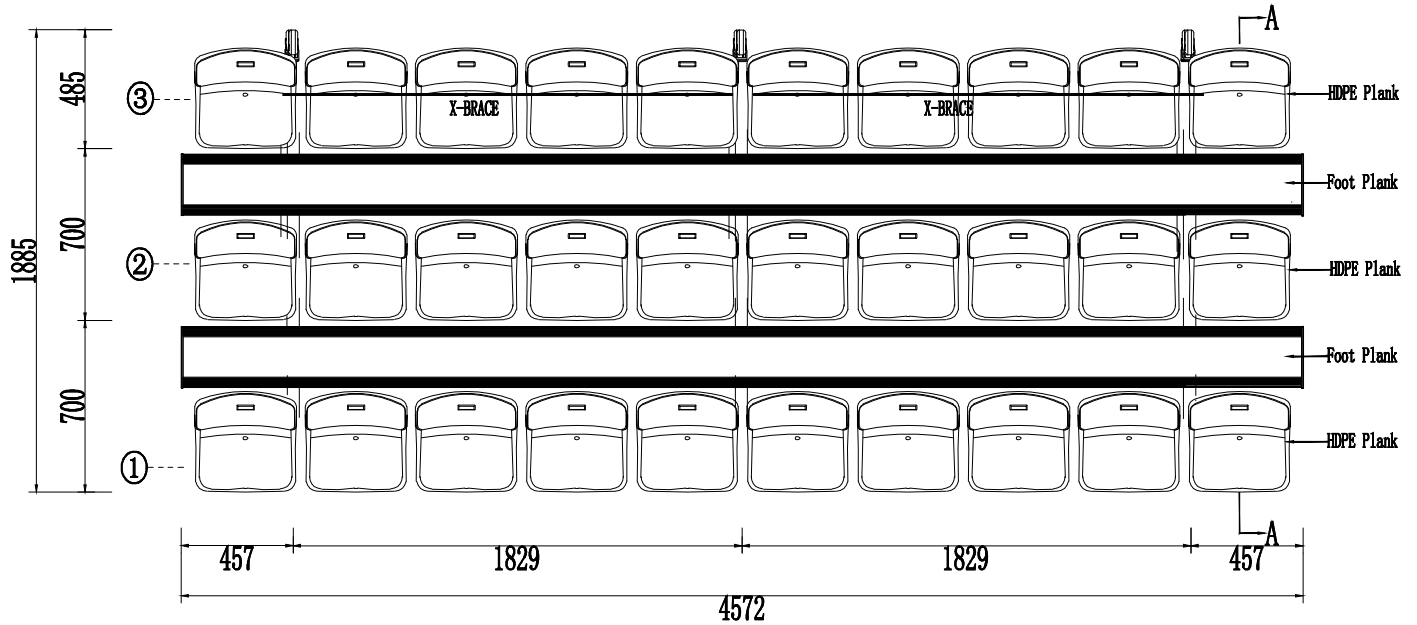

SEATING PLAN

		Mountain bleacher	
SCALE	1:100	http://www.mountainbleacher.com	
DATE	2020/1/27	https://www.mountainbleacher.com	
DESIGN	Mr. Lan	Tel: 008615070297138 / 008618079222225	
CHECK	Mr. Cheng	E-mail: dong@mountainbleacher.com	
TITLE		No. 1	

Size table	S	M	L	XL
Row Spacing	650mm	700mm	750mm	800mm

Seat model optional

SEAT PLANK	Live Load	advice	choose
------------	-----------	--------	--------

1	300*50*100 Aluminum alloy	2.13kn/m ²	★★★★
---	---------------------------	-----------------------	------

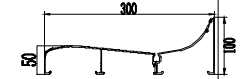

2	291*50*2 Aluminum alloy	1.98kn/m ²	★★★★★
---	-------------------------	-----------------------	-------

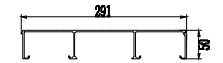

3	250*50*2 Aluminum alloy	1.77kn/m ²	★★★★
---	-------------------------	-----------------------	------



4	250*38*2 Aluminum alloy	1.01kn/m ²	No
---	-------------------------	-----------------------	----



5	300*450*100 HDPE	1.78kn/m ²	★★
---	------------------	-----------------------	----



6	410*417*175 HDPE	1.76kn/m ²	No
---	------------------	-----------------------	----

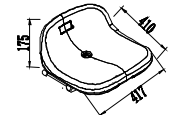

7	450*410*330 HDPE	1.76kn/m ²	No
---	------------------	-----------------------	----

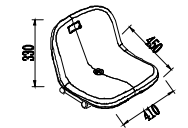

UNIT:mm

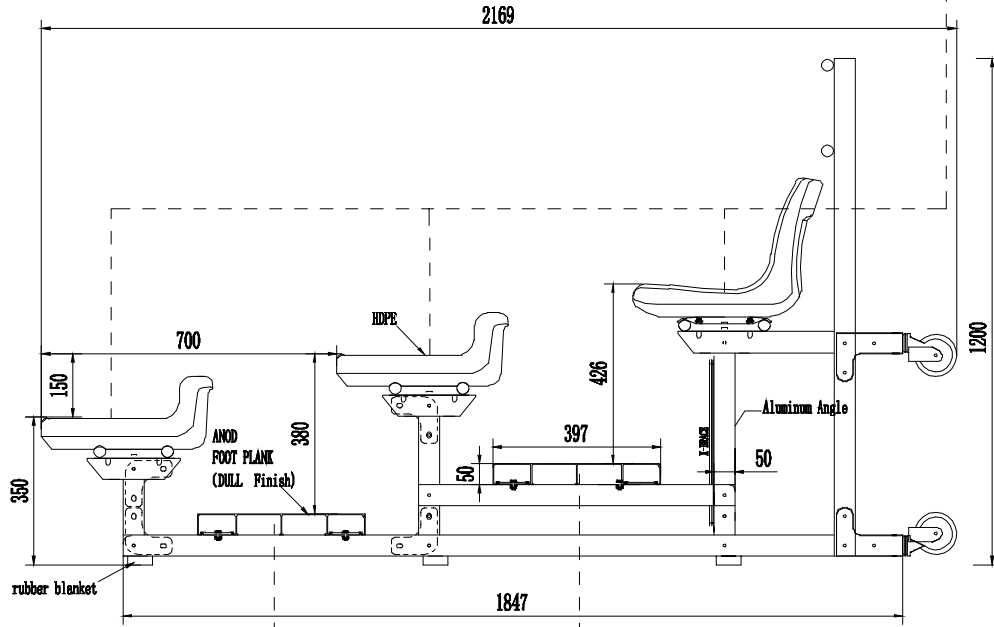

Side view AA

FOOT PLANK	1	2	3	4
	397*50*2 Aluminum alloy	291*50*2 Aluminum alloy	250*50*2 Aluminum alloy	250*38*2 Aluminum alloy
Live Load	2.81kn/m ²	2.06kn/m ²	1.77kn/m ²	1.01kn/m ²
advice	★★	★★★★★	★★★★	No

Mountain bleacher

SCALE 1:100 <http://www.mountainbleacher.com>

DATE 2020/7/27 <https://www.mountainbleacher.com>

DESIGN Mr. Liu <https://www.mountainbleacher.com>

CHECK Mr. Chang Tel: 008618879222225, 008615070297138

TITLE E-mail: dong@mountainbleacher.com

PK 1

Size table	S	M	L	XL
Row Spacing	650mm	700mm	750mm	800mm
		√		

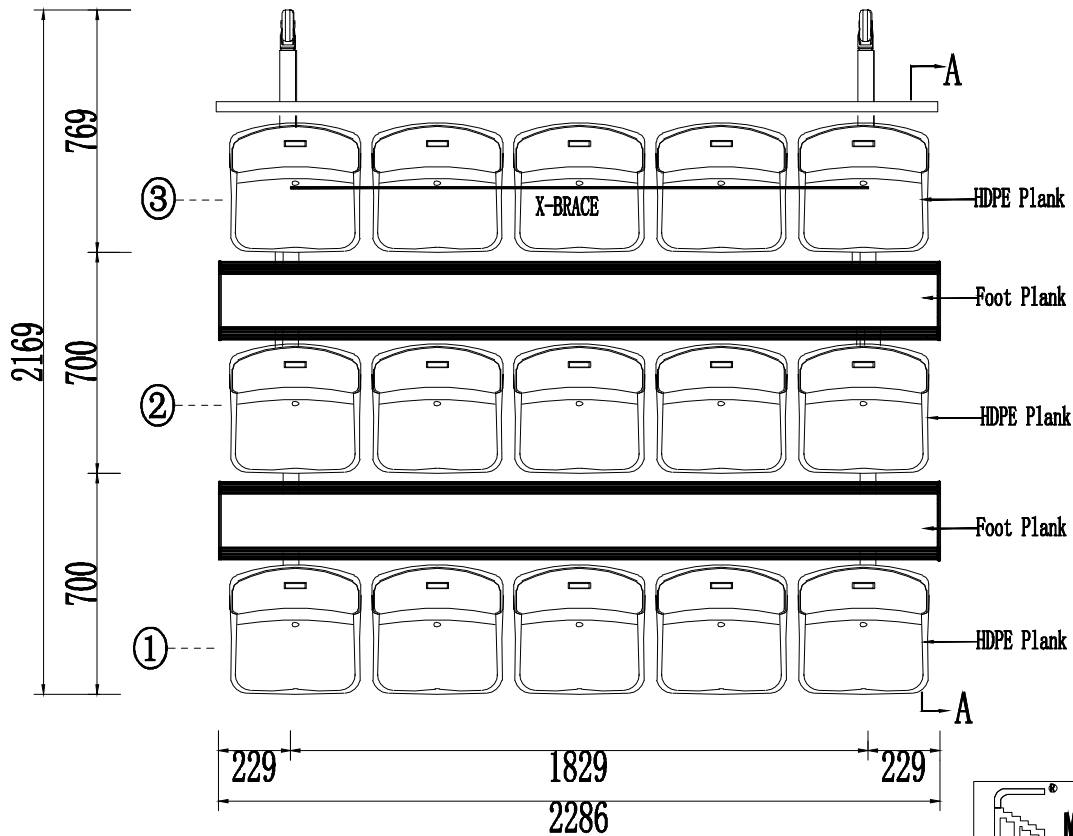

SEATING PLAN

 Mountain bleacher		
SCALE	1:100	http://www.mchair.com
DATE	2020/7/27	http://www.mountainbleacher.com
DESIGN	Mr. Lau	Tel: 008615070297130 / 008618879222226
CHECK	Mr. Cheung	E-mail: dong@mountainbleacher.com
TITLE		1

Size table	S	M	L	XL
Row Spacing	650mm	700mm	750mm	800mm
		↓		

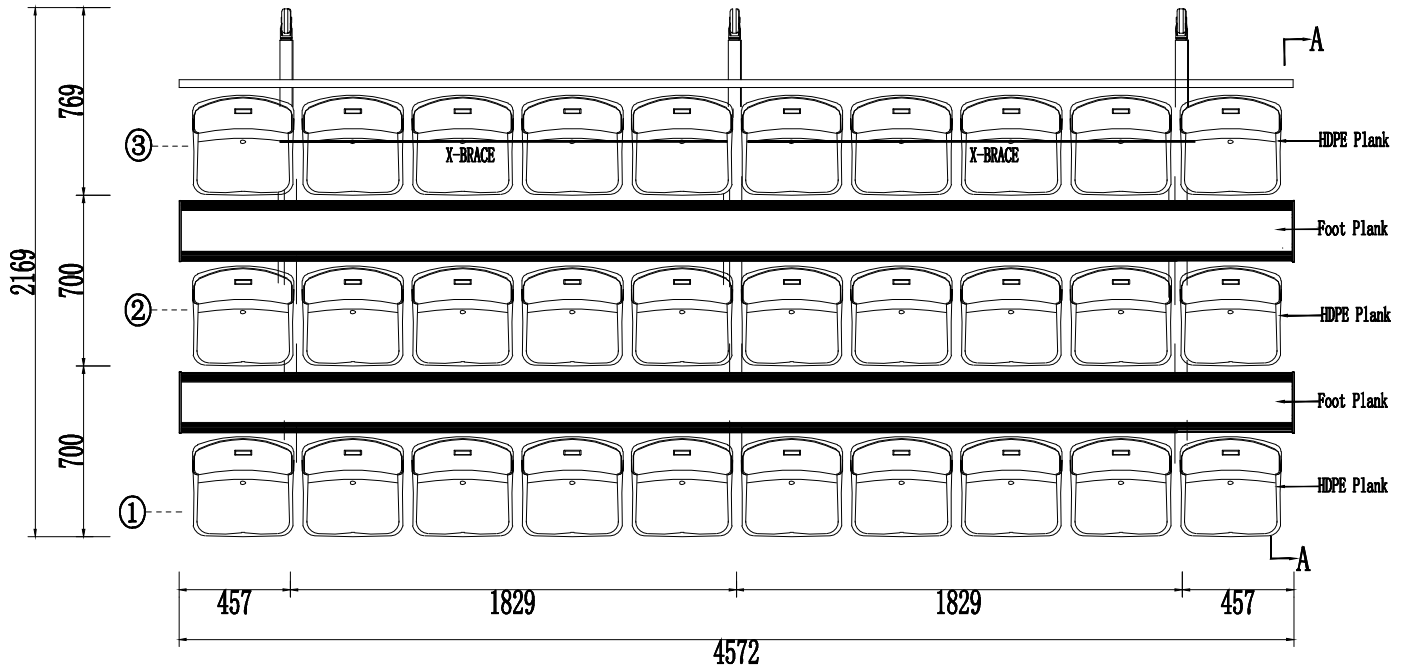

SEATING PLAN

 Mountain bleacher		
SCALE	1:100	http://www.mountainbleacher.com
DATE	2020/7/23	https://www.mountainbleacher.com
DESIGN	Mr. Lau	Tel: 008615070297138 / 00861857922225
CHECK	Mr. Chung	E-mail: dong@mountainbleacher.com
TITLE		NO. 1

Size table	S	M	L	XL
Row Spacing	650mm	700mm	750mm	800mm
		√		

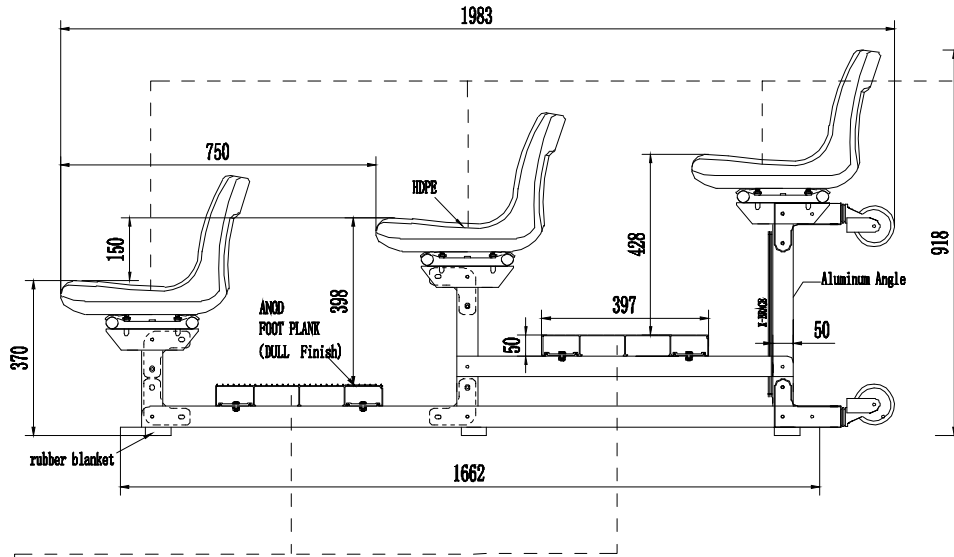

Side view AA

UNIT:mm

Seat model optional

	SEAT PLANK	Live Load	advice	choose
1	300*60*100 Aluminum alloy	2.13kn/m ²	★★★	
2	291*60*2 Aluminum alloy	1.96kn/m ²	★★★★	
3	250*60*2 Aluminum alloy	1.77kn/m ²	★★★★	
4	250*38*2 Aluminum alloy	1.01kn/m ²	No	
5	300*450*100 HDPE	1.76kn/m ²	★★	
6	410*417*175 HDPE	1.76kn/m ²	No	
7	450*410*330 HDPE	1.76kn/m ²	No	

FOOT PLANK	1	2	3	4
	397*50*2 Aluminum alloy	291*50*2 Aluminum alloy	250*50*2 Aluminum alloy	250*38*2 Aluminum alloy
Live Load	2.81kn/m ²	2.06kn/m ²	1.77kn/m ²	1.01kn/m ²
advice choose	★★	★★★★	★★★	No

Mountain bleacher

SCALE: 1:100 <http://www.mocheir.com>

DATE: 2020/7/27 <https://www.sourceinbleacher.com>

DESIGN: Mr. Len Tel:00861887922225.008615070297138

CHECK: Mr. Chang E-mail:dong@mountainbleacher.com

TITLE: _____

Size table	S	M	L	XL
Row Spacing	650mm	700mm	750mm	800mm
				✓

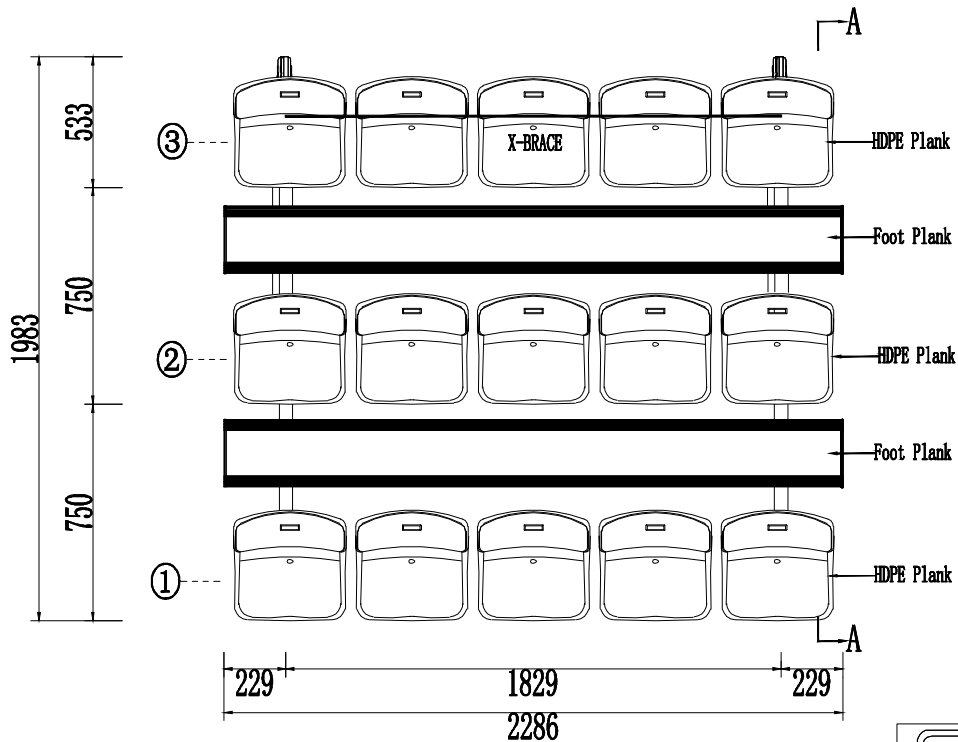

SEATING PLAN

 Mountain bleacher		
SCALE	1:100	http://www.mountainbleacher.com
DATE	2020/7/27	http://www.mountainbleacher.com
DESIGN	Mr. Lam	Tel: 008615070297198 / 008618879222225
CHECK	Mr. Cheung	E-mail: dong@mountainbleacher.com
TITLE		1/1

Size table	S	M	L	XL
Row Spacing	650mm	700mm	750mm	800mm
				√

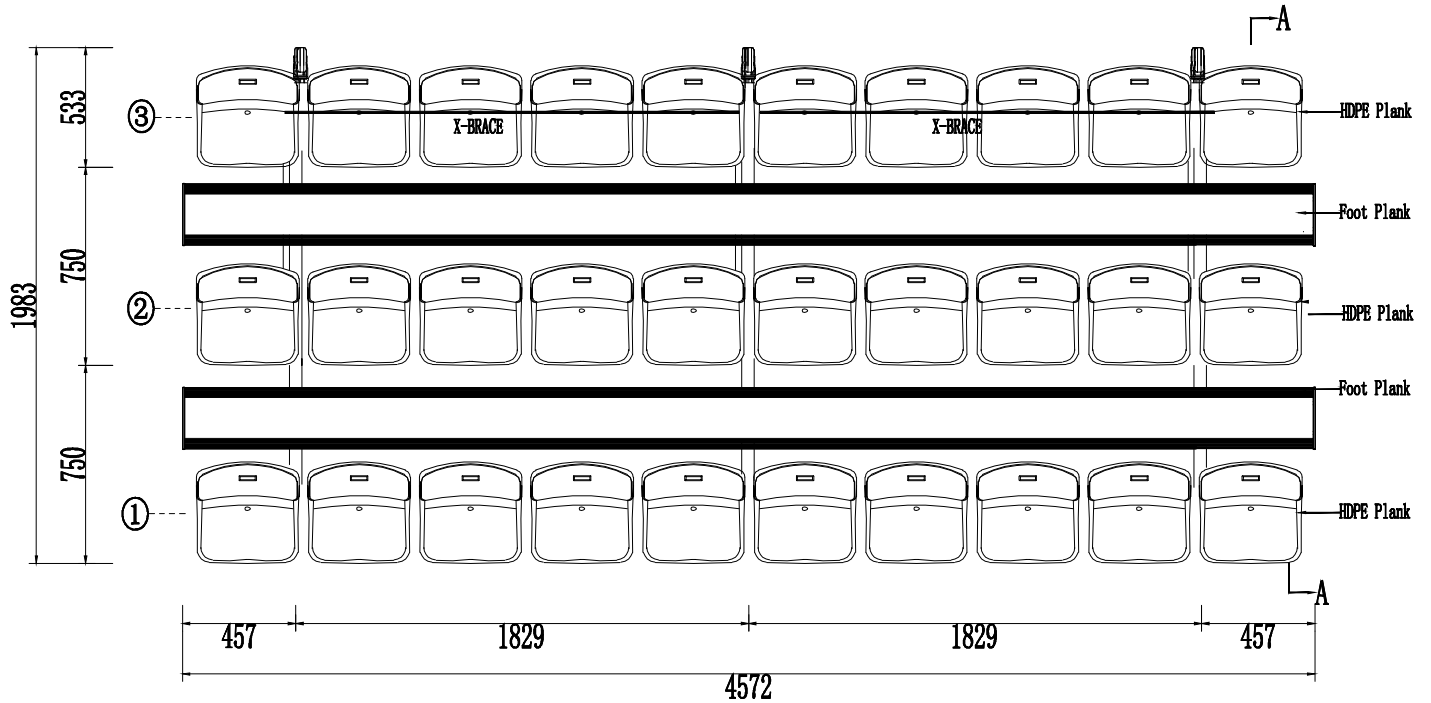

SEATING PLAN

 Mountain bleacher		
SCALE	1:100	http://www.mountainbleacher.com
DATE	2020/7/27	https://www.mountainbleacher.com
DESIGN	Mr. Lau	Tel: 008615070297138 / 00861867922225
CHECK	Mr. Cheng	E-mail: dong@mountainbleacher.com
TITLE		NO. 1

Size table	S	M	L	XL
Row Spacing	650mm	700mm	750mm	800mm

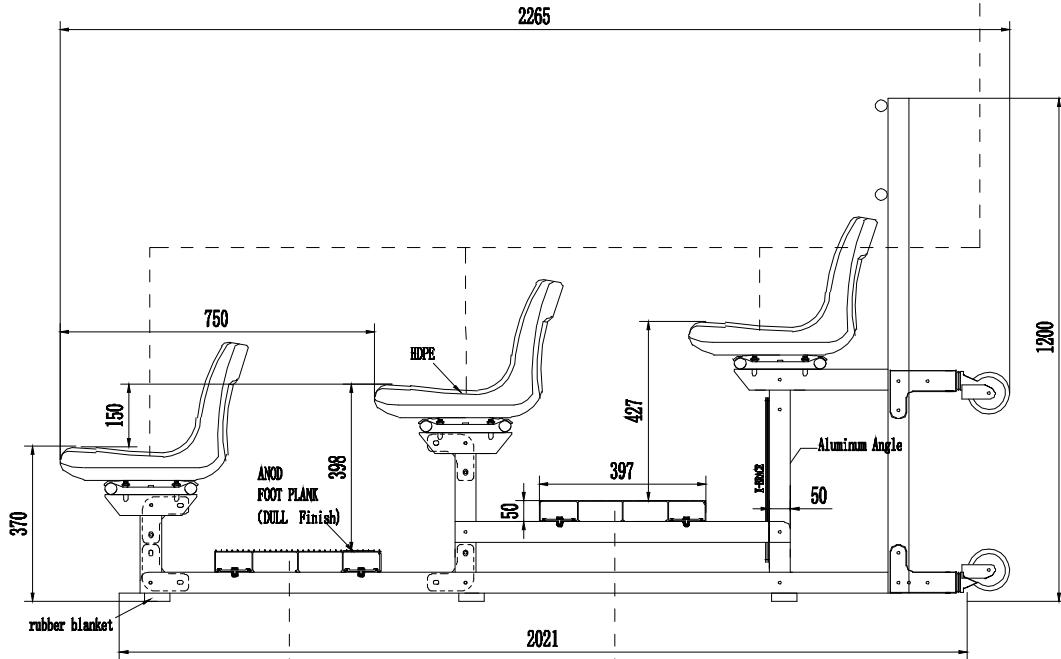

Side view AA

UNIT:mm

Seat model optional

SEAT PLANK	Live Load	advice/choose
1 300*60*100 Aluminum alloy	2.13 kn/m ²	★★★
2 291*50*2 Aluminum alloy	1.98 kn/m ²	★★★★★
3 250*50*2 Aluminum alloy	1.77 kn/m ²	★★★★★
4 250*38*2 Aluminum alloy	1.01 kn/m ²	No
5 300*60*100 HDPE	1.76 kn/m ²	★★
6 410*117*175 HDPE	1.76 kn/m ²	No
7 450*410*330 HDPE	1.76 kn/m ²	No
Mountain bleacher		
SCALE	1:100	http://www.mountainbleacher.com
DATE	2020/7/27	https://www.mountainbleacher.com
DESIGN	Mr. Lau	Tel: 008618879222225, 008615070297138
CHECK	Mr. Chang	E-mail: dong@mountainbleacher.com
TITLE		1

FOOT PLANK	1 397*50*2 Aluminum alloy	2 291*50*2 Aluminum alloy	3 250*50*2 Aluminum alloy	4 250*38*2 Aluminum alloy
Live Load	2.81 kn/m ²	2.06 kn/m ²	1.77 kn/m ²	1.01 kn/m ²
advice/choose	★★	★★★★★	★★★★	No

Size table	S	M	L	XL
Row Spacing	650mm	700mm	750mm	800mm
			√	

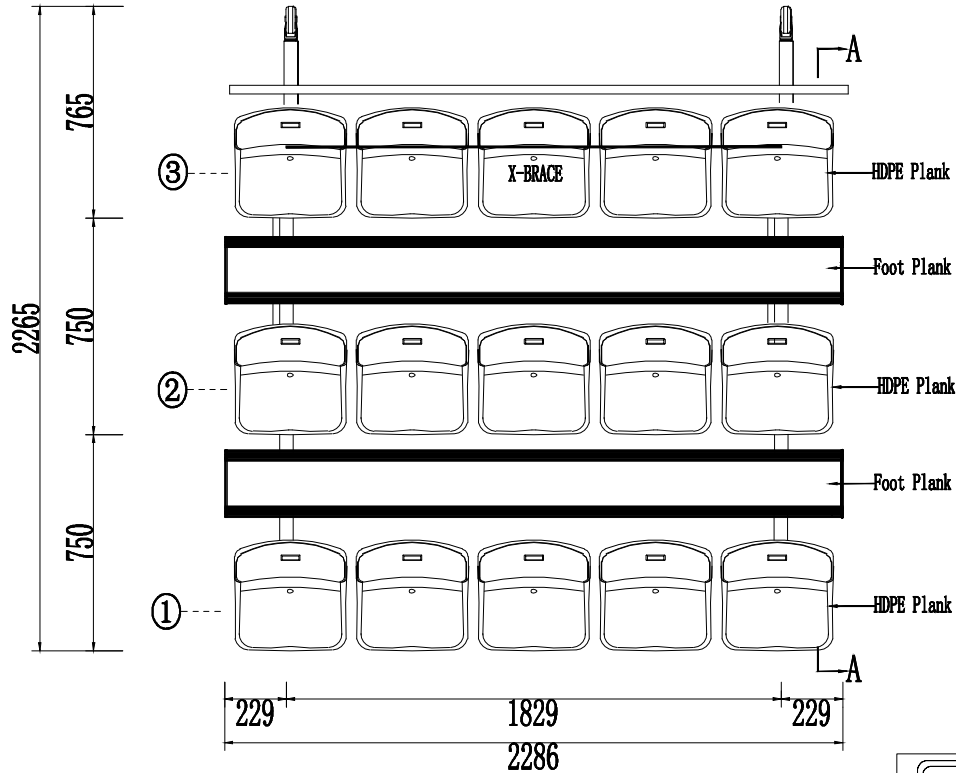

SEATING PLAN

 Mountain bleacher		
		SCALE 1:100
DATE 2020/11/22	http://www.mountainbleacher.com	
DESIGN Mr. Lan	Tel: 008615070297138 / 008618879222226	
CHECK Mr. Chang	E-mail: dong@mountainbleacher.com	
TITLE		No. 1

Size table	S	M	L	XL
Row Spacing	650mm	700mm	750mm	800mm
			√	

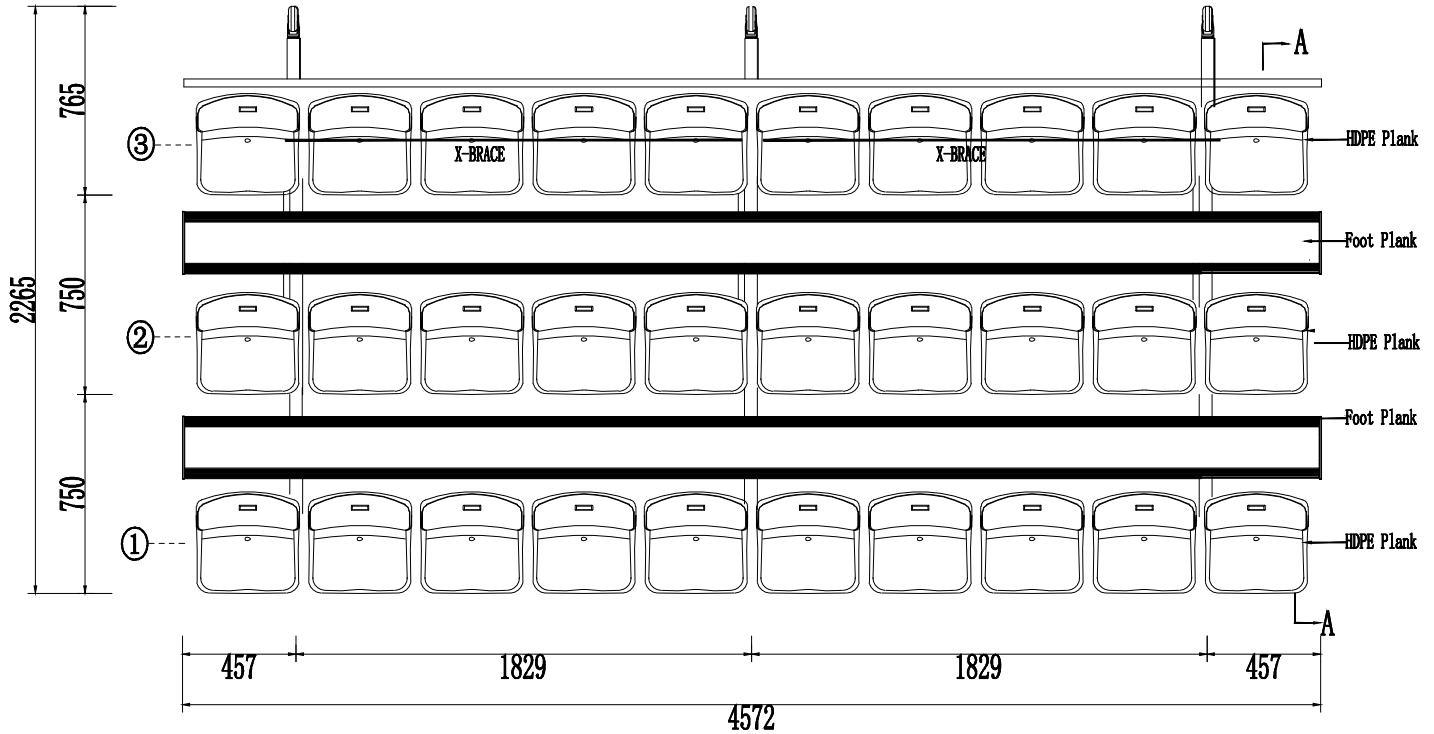

SEATING PLAN

 Mountain bleacher	
SCALE	1:100 http://www.mochair.com
DATE	2020/7/27 https://www.mountainbleacher.com
DESIGN	Mr. Lau
CHECK	Mr. Cheng Tel: 008615070297138 / 008618879222225
TITLE	E-mail: dong@mountainbleacher.com
	NO. 1