

Size table	S	M	L	XL
Row Spacing	660mm	700mm	750mm	800mm
	↓			

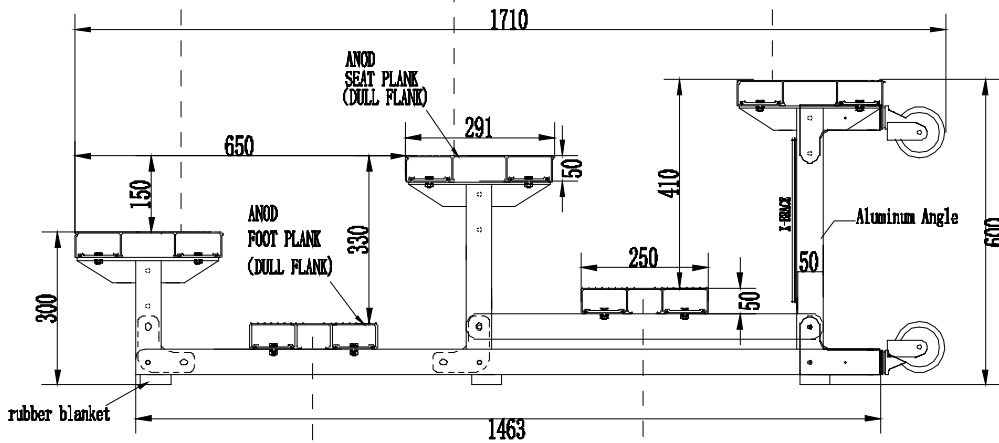

Side view AA

UNIT:mm

Seat model optional

SEAT PLANK Live Load advice choose

1	300*50*100 Aluminum alloy	2.19 kn/m ²	★★★	
---	---------------------------	------------------------	-----	--

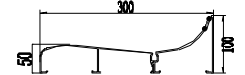

2	291*50*2 Aluminum alloy	1.98 kn/m ²	★★★★★	
---	-------------------------	------------------------	-------	--

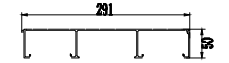

3	250*50*2 Aluminum alloy	1.77 kn/m ²	★★★★★	
---	-------------------------	------------------------	-------	--

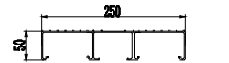

4	250*38*2 Aluminum alloy	1.01 kn/m ²	No	
---	-------------------------	------------------------	----	--

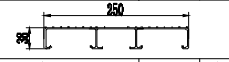

5	300*450*100 EDPE	1.76 kn/m ²	★★	
---	------------------	------------------------	----	--



6	410*417*175 EDPE	1.76 kn/m ²	No	
---	------------------	------------------------	----	--

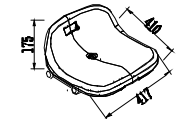

7	450*410*330 EDPE	1.76 kn/m ²	No	
---	------------------	------------------------	----	--

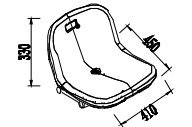

FOOT PLANK	1	397*50*2 Aluminum alloy	2	291*50*2 Aluminum alloy	3	250*50*2 Aluminum alloy	4	250*38*2 Aluminum alloy
Live Load	2.81 kn/m ²		2.06 kn/m ²		1.77 kn/m ²		1.01 kn/m ²	
advice choose	★★		★★★★★		★★★★★		No	

Mountain bleacher

SCALE 1:100 ID 3P-W650-P250-S291

DATE 2020/7/27 <https://www.mountainbleacher.com>

DESIGN Mr. Liu TEL: 008618879222223 008615070297138

CHECK Mr. Chang E-mail: dong@mountainbleacher.com

TITLE

Size table	S	M	L	XL
Row Spacing	650mm	700mm	750mm	800mm
	↓			

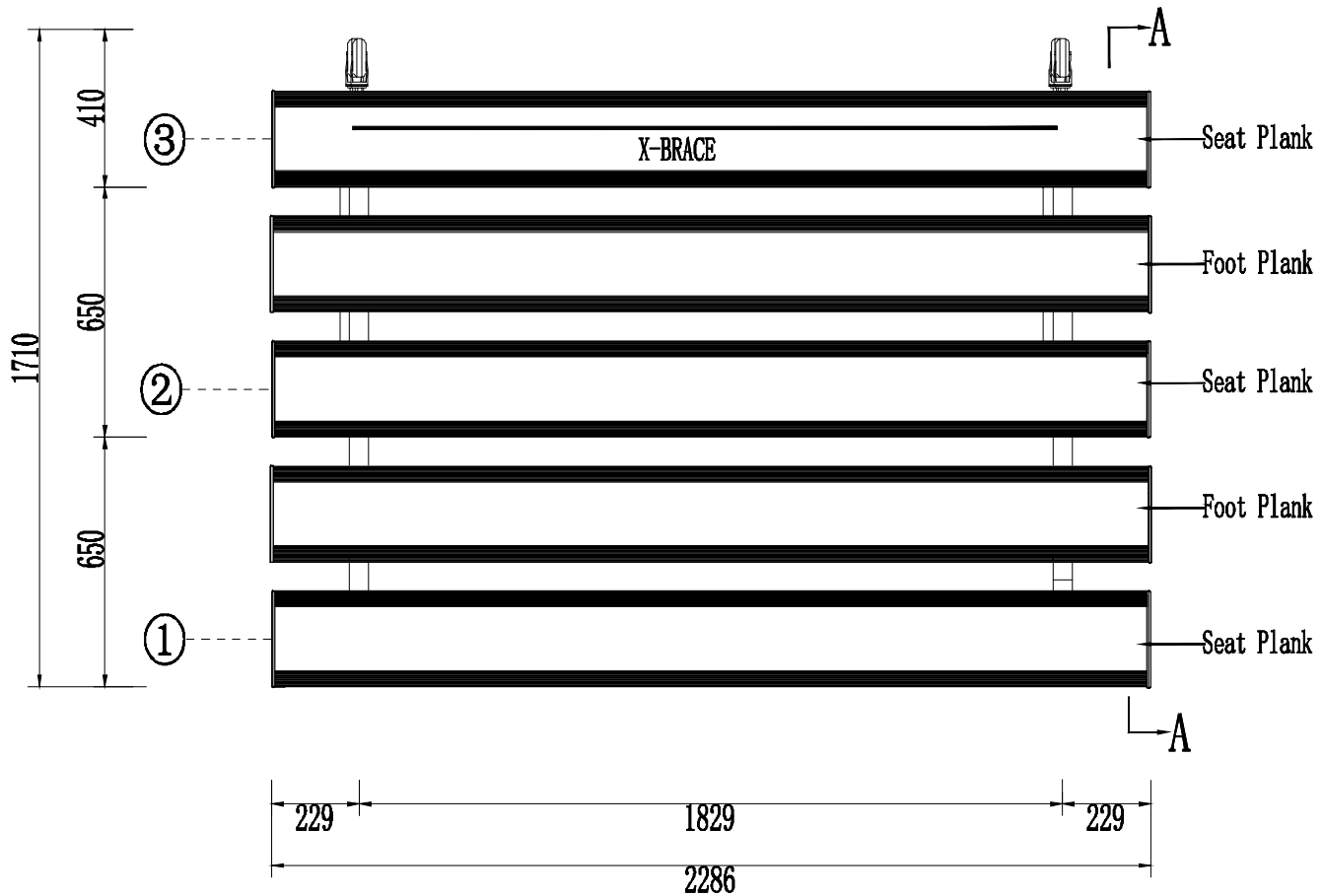

SEATING PLAN

UNIT: mm

 Mountain bleacher			
SCALE	1:100	ID	3P-W650-F250-S291
DATE	2020/7/27	https://www.mountainbleacher.com	
DESIGN	Mr. Leo	Tel: 008615070297136 / 008618879222226	
CHECK	Mr. Cheng	E-mail: dong@mountainbleacher.com	
TITLE			NO. 1

Size table	S	M	L	XL
Row Spacing	650mm	700mm	750mm	800mm
	√			

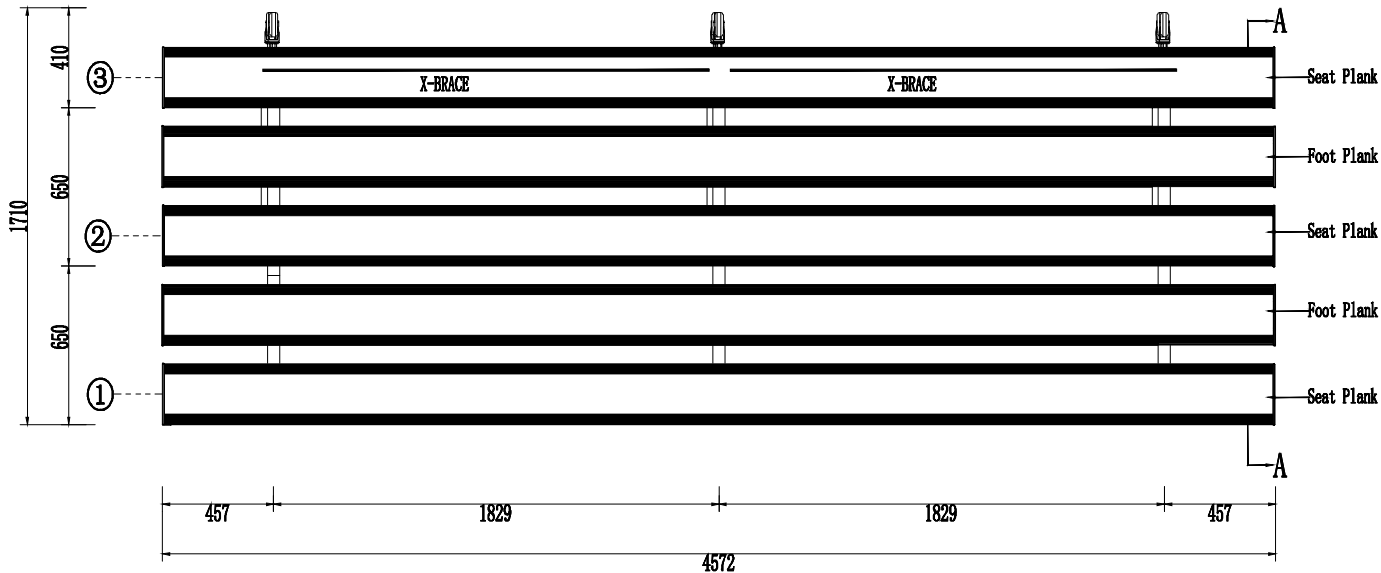

SEATING PLAN

UNIT: mm

 Mountain bleacher			
SCALE	1:100	ID	3P-W650-F250-S291
DATE	2020/1/27	https://www.mountainbleacher.com	
DESIGN	Mr. Lau	Tel: 008615070297138 / 008618879222226	
DRAWN	Mr. Cheung	E-mail: dong@mountainbleacher.com	
TITLE		1	

Size table	S	M	L	XL
Row Spacing	650mm	700mm	750mm	800mm
	√			

Seat model optional

SEAT PLANK	Live Load	advice	choose
------------	-----------	--------	--------

1	300*50*2 Aluminum alloy	2.13kn/m ²	★★★
---	-------------------------	-----------------------	-----

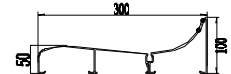

2	291*50*2 Aluminum alloy	1.98kn/m ²	★★★★★
---	-------------------------	-----------------------	-------

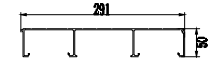

3	250*50*2 Aluminum alloy	1.77kn/m ²	★★★★★
---	-------------------------	-----------------------	-------

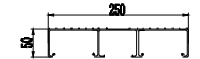

4	250*38*2 Aluminum alloy	1.01kn/m ²	No
---	-------------------------	-----------------------	----

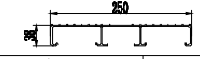

5	300*450*100 HDPE	1.76kn/m ²	★★
---	------------------	-----------------------	----



6	410*417*176 HDPE	1.76kn/m ²	No
---	------------------	-----------------------	----

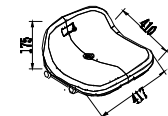

7	450*410*330 HDPE	1.76kn/m ²	No
---	------------------	-----------------------	----

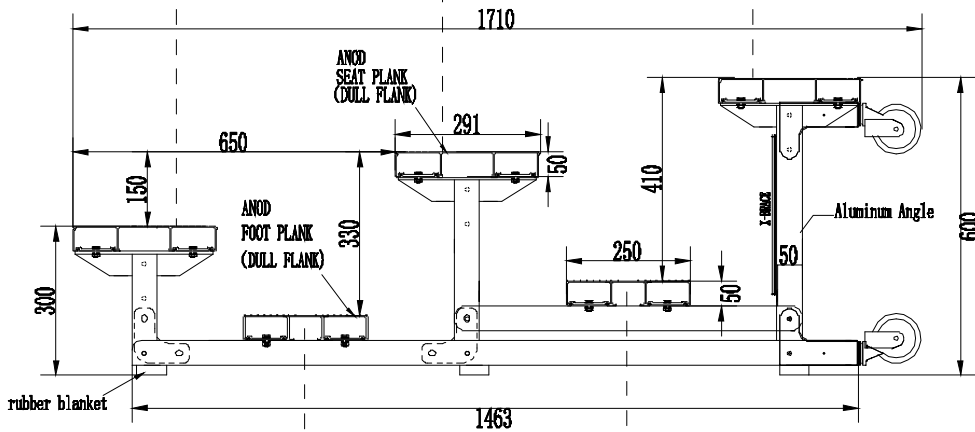
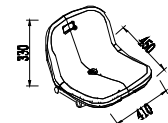

Side view AA

UNIT:mm

FOOT PLANK	1	2	3	4
	397*50*2 Aluminum alloy	291*50*2 Aluminum alloy	250*50*2 Aluminum alloy	250*38*2 Aluminum alloy
Live Load	2.81kn/m ²	2.06kn/m ²	1.77kn/m ²	1.01kn/m ²
advice choose	★★	★★★★★	★★★★	No



Mountain bleacher

SCALE	1:100	ID	3F-V650-P250-S291
DATE	2020/7/27	URL	https://www.mountainbleacher.com
DESIGN	Mr. Lau	PHONE	Tel: 008618879222228, 008618070297138
CHECK	Mr. Cheng	E-MAIL	dong@mountainbleacher.com
TITLE			

Size table	S	M	L	XL
Row Spacing	650mm	700mm	750mm	800mm
	↓			

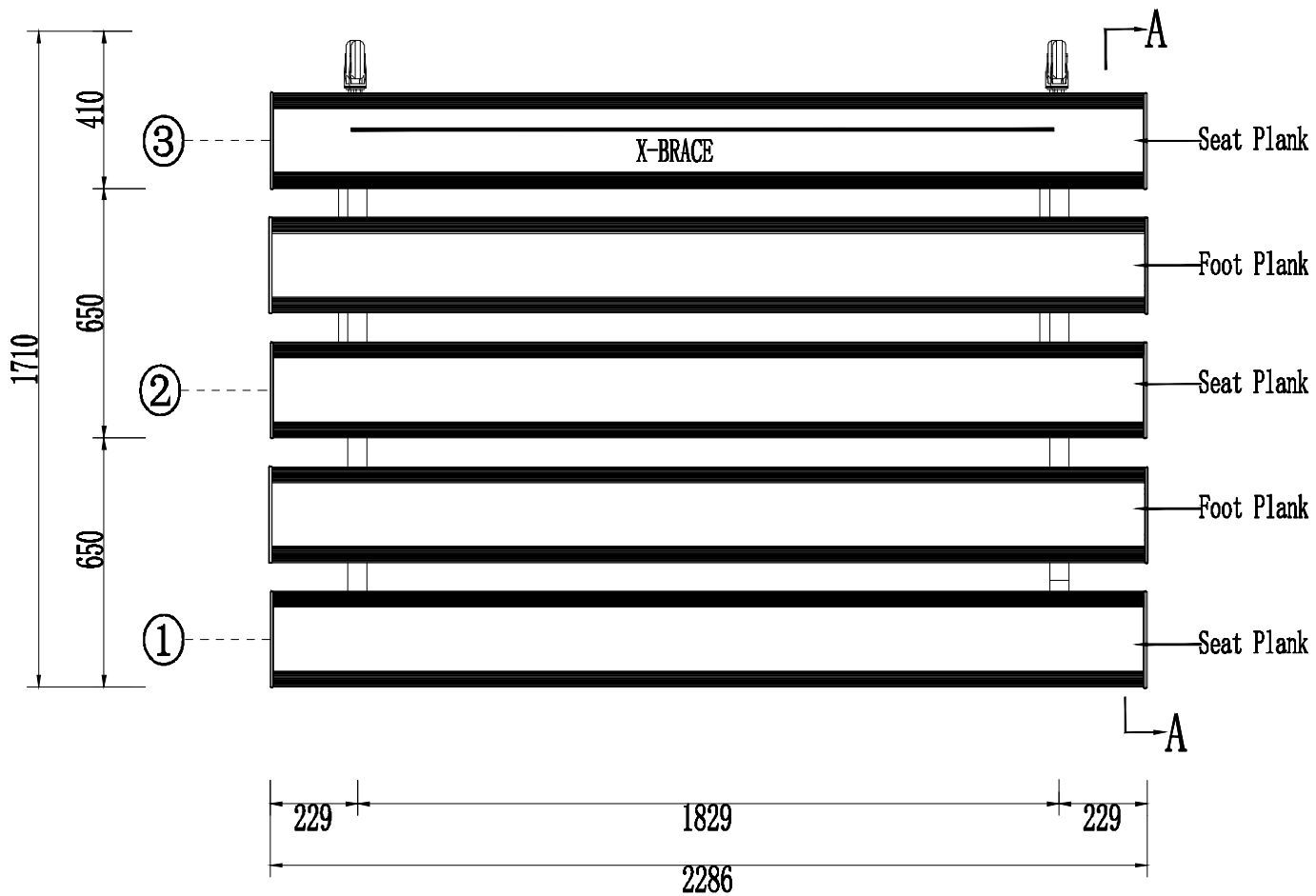

SEATING PLAN

UNIT: mm

 Mountain bleacher	
SCALE: 1:100	ID: 3P-W650-F250-S291
DATE: 2020/11/23	https://www.mountainbleacher.com
DESIGN: Mr. Lei	Tel: 008615070297138 / 008618879222226
DRAW: Mr. Cheng	E-mail: dong@mountainbleacher.com
TITLE:	NO. 1

Size table	S	M	L	XL
Row Spacing	650mm	700mm	750mm	800mm

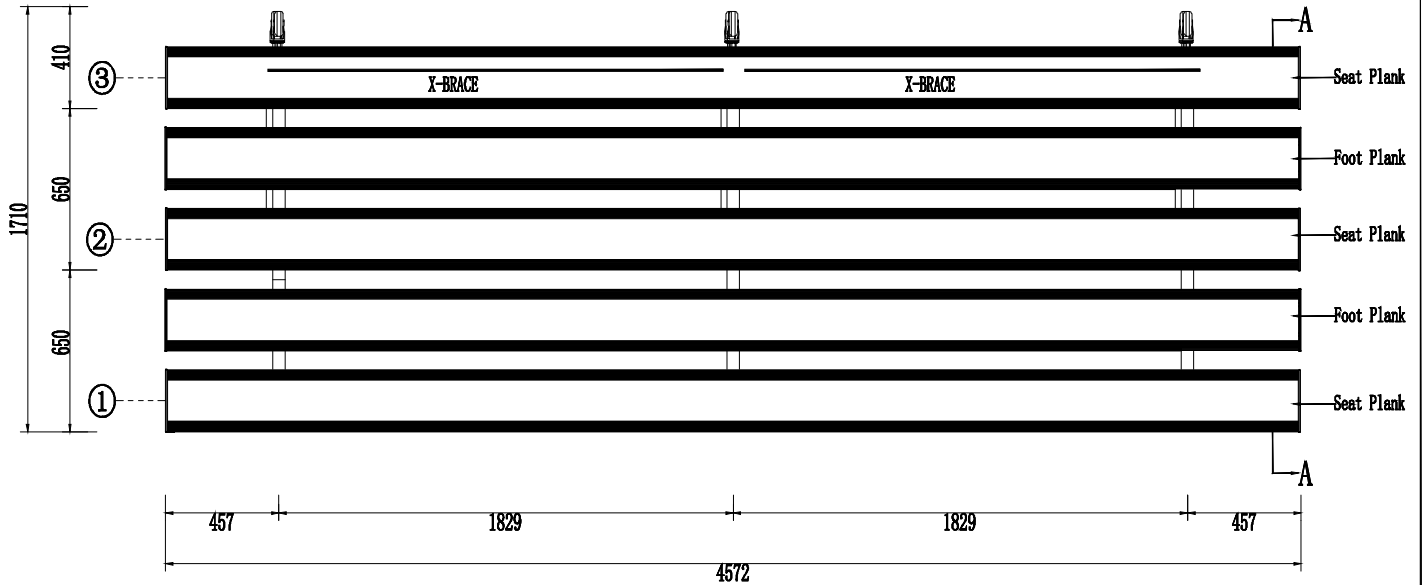

SEATING PLAN

 Mountain bleacher			
SCALE	1:100	ID	3F-W650-F250-S291
DATE	2020/7/27	https://www.mountainbleacher.com	
DESIGN	Mr. Lan	Tel: 008615070297138 / 00861887222225	
CHECK	Mr. Chang	E-mail: dong@mountainbleacher.com	
TITLE		NO.	1

UNIT: mm

Size table	S	M	L	XL
Row Spacing	650mm	700mm	750mm	800mm
	√			

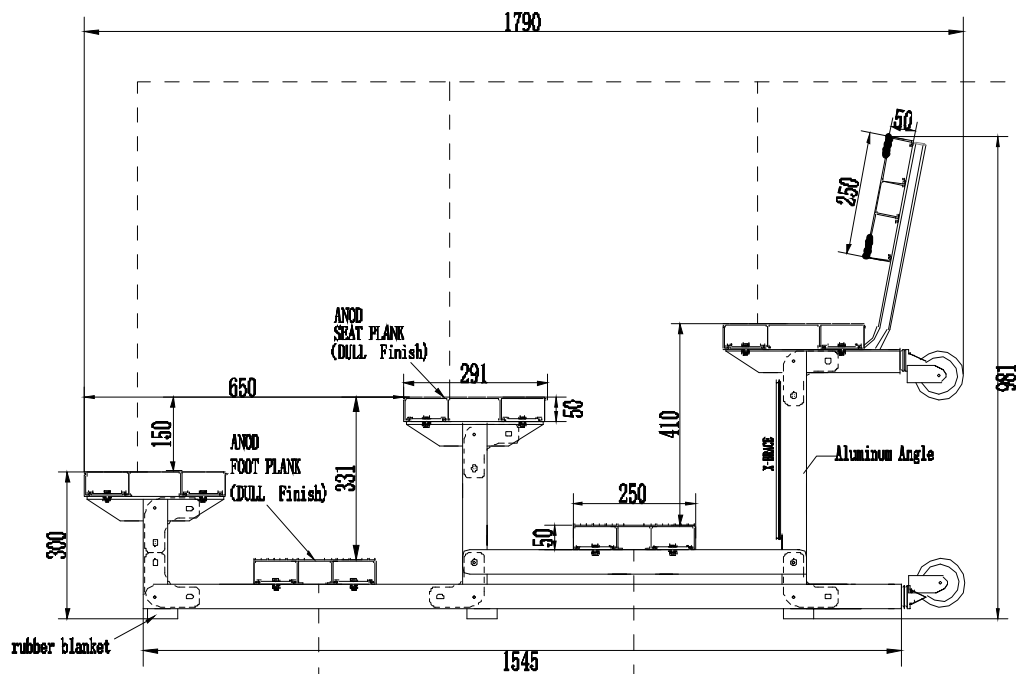

Side view AA

UNIT:mm

FOOT PLANK	1	397*50*2 Aluminum alloy	2	291*50*2 Aluminum alloy	3	250*50*2 Aluminum alloy	4	250*38*2 Aluminum alloy
Live Load	2.81kn/m ²		2.06kn/m ²		1.77kn/m ²		1.01kn/m ²	
advice	★★		★★★★		★★★★		No	

Seat model optional

SEAT PLANK		Live Load	advice	choose
1	300*50*100 Aluminum alloy	2.33kn/m ²	★★★★	
2	291*50*2 Aluminum alloy	1.98kn/m ²	★★★★★	
3	250*50*2 Aluminum alloy	1.77kn/m ²	★★★★	
4	250*38*2 Aluminum alloy	1.01kn/m ²	No	
5	300*450*100 HDPE	1.75kn/m ²	★★	
6	410*417*175 HDPE	1.75kn/m ²	No	
7	450*410*330 HDPE	1.75kn/m ²	No	
		Mountain bleacher		
SCALE	1:100	ID	3F-V650-P250-S291-B250	
DATE	2020/12/27	https://www.mountainbleacher.com		
DESIGN	Mr. Len	Tel: 008618577222228, 00861800297138		
CHECK	Mr. Cheng	E-mail: douglsmountainbleacher.com		
TITLE		No.	1	

Size table	S	M	L	XL
Row Spacing	650mm	700mm	750mm	800mm
	√			

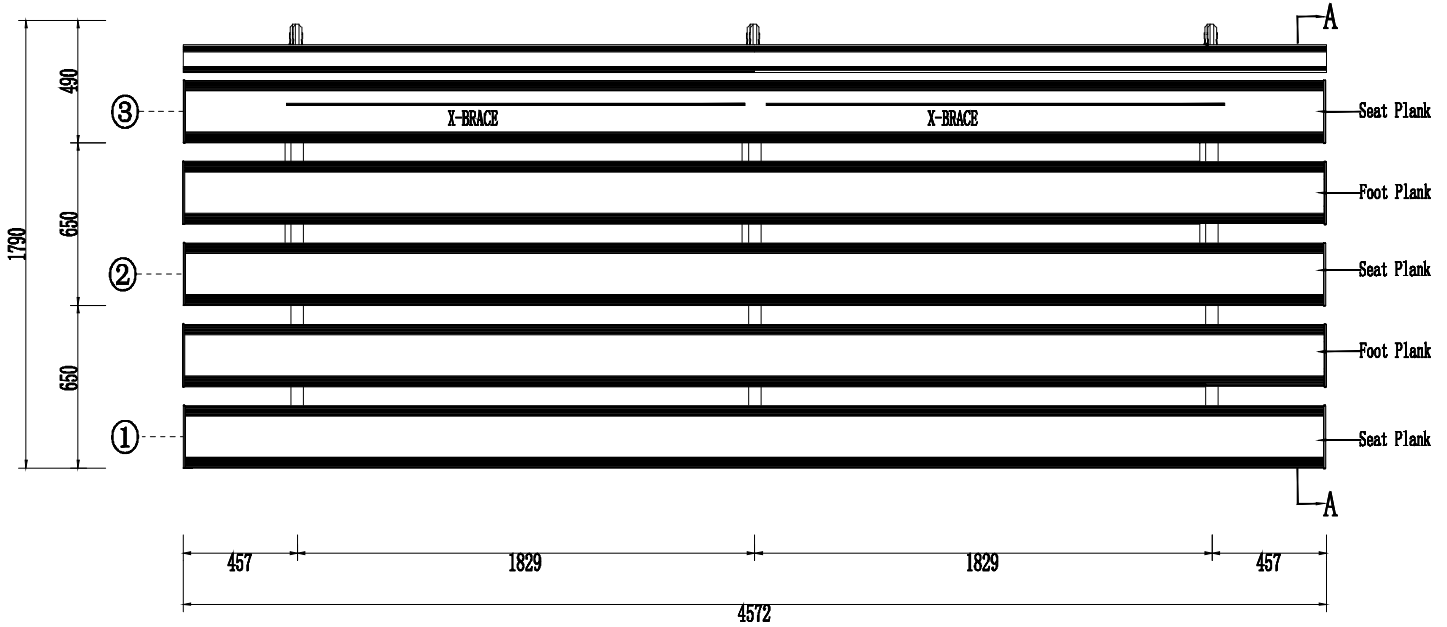

 Mountain bleacher			
SCALE	1:100	ID	3F-W650-F250-S291-B250
DATE	2020/7/27	URL	https://www.mountainbleacher.com
DESIGN	Mr. Lam	PHONE	Tel: 008618070297138 / 008618879222228
CHECK	Mr. Cheung	E-MAIL	E-mail: dong@mountainbleacher.com
TITLE			

UNIT: mm

Size table	S	M	L	XL
Row Spacing	650mm	700mm	750mm	800mm
	√			

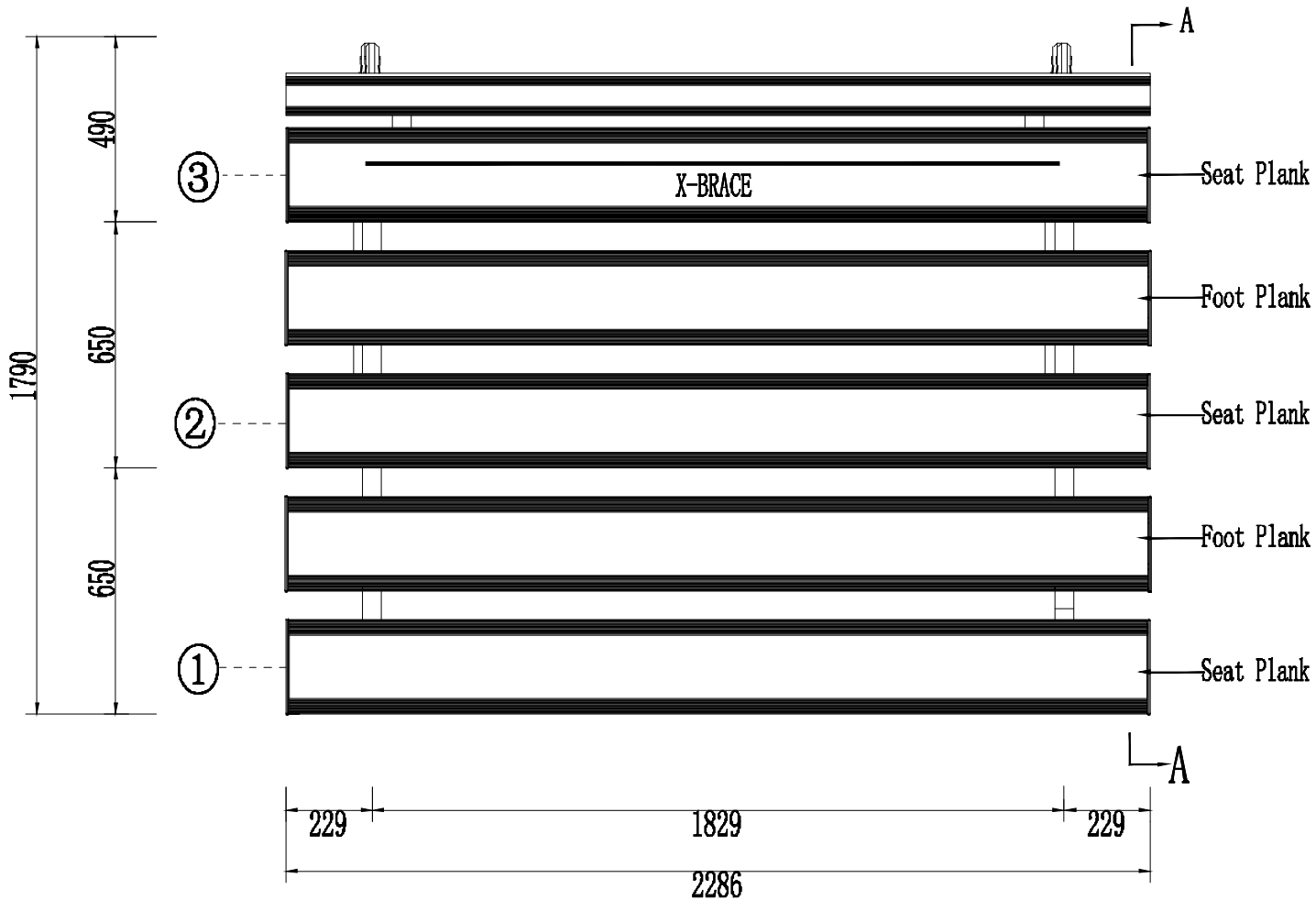

 Mountain bleacher			
SCALE	1:100	ID	3F-W650-F250-S291-B250
DATE	2020/7/27	DESIGN	https://www.mountainbleacher.com
CHECK	Mr. Lan	TEL	Tel: 008615070297138 / 008618879222228
TITLE	Mr. Cheung	E-MAIL	E-mail: dong@mountainbleacher.com

UNIT: mm

Size table	S	M	L	XL
Row Spacing	650mm	700mm	750mm	800mm
		√		

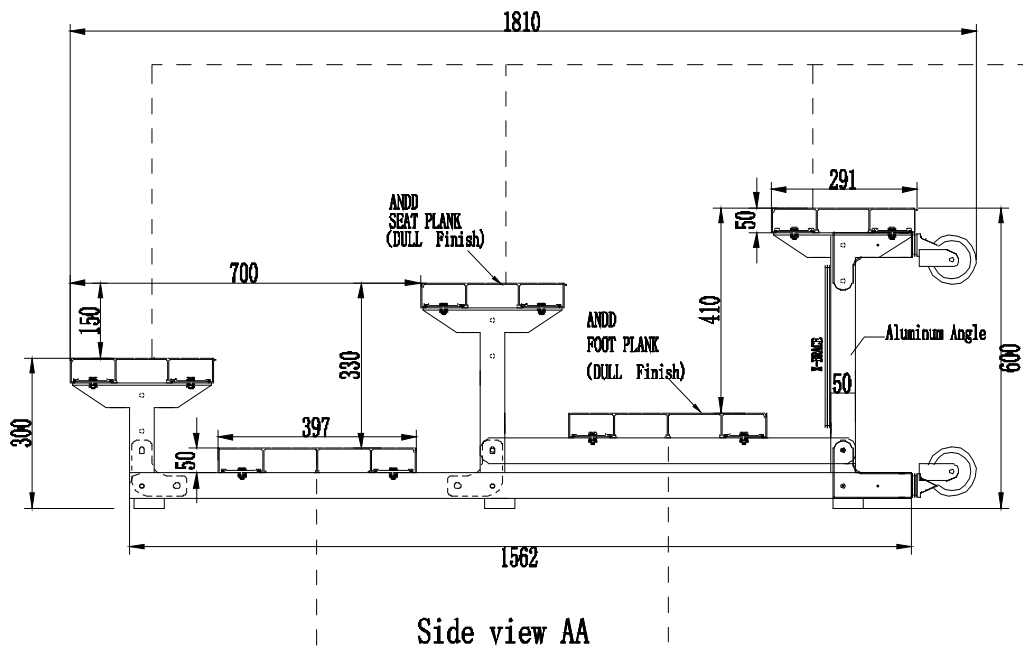

UNIT:mm

Seat model optional

SEAT PLANK		Live Load	advicelchoose
1	300*50*100 Alumium alloy	2.13kn/m ²	★★★
2	291*50*2 Alumium alloy	1.96kn/m ²	★★★★
3	250*50*2 Alumium alloy	1.77kn/m ²	★★★★
4	250*38*2 Alumium alloy	1.01kn/m ²	No
5	900*150*100 HDPE	1.76kn/m ²	★★
6	410*417*175 HDPE	1.76kn/m ²	No
7	450*410*330 HDPE	1.76kn/m ²	No

FOOT PLANK	1	2	3	4
	397*50*2 Alumium alloy	291*50*2 Alumium alloy	250*50*2 Alumium alloy	250*38*2 Alumium alloy
Live Load	2.81kn/m ²	2.06kn/m ²	1.77kn/m ²	1.01kn/m ²
advicelchoose	★★	★★★★	★★★★	No

Mountain bleacher

MODEL: 1:100 TD: 3K-0700-F397-S291

DATE: 2020/7/27 <https://www.mountainbleacher.com>

DESIGN: Mr. Lau PING Tel: 008618879222225, 008615078297138

CHECK: Mr. Cheung E-mail: dong@mountainbleacher.com

TITLE: _____ NO: 1

Size table	S	M	L	XL
Row Spacing	650mm	700mm	750mm	800mm

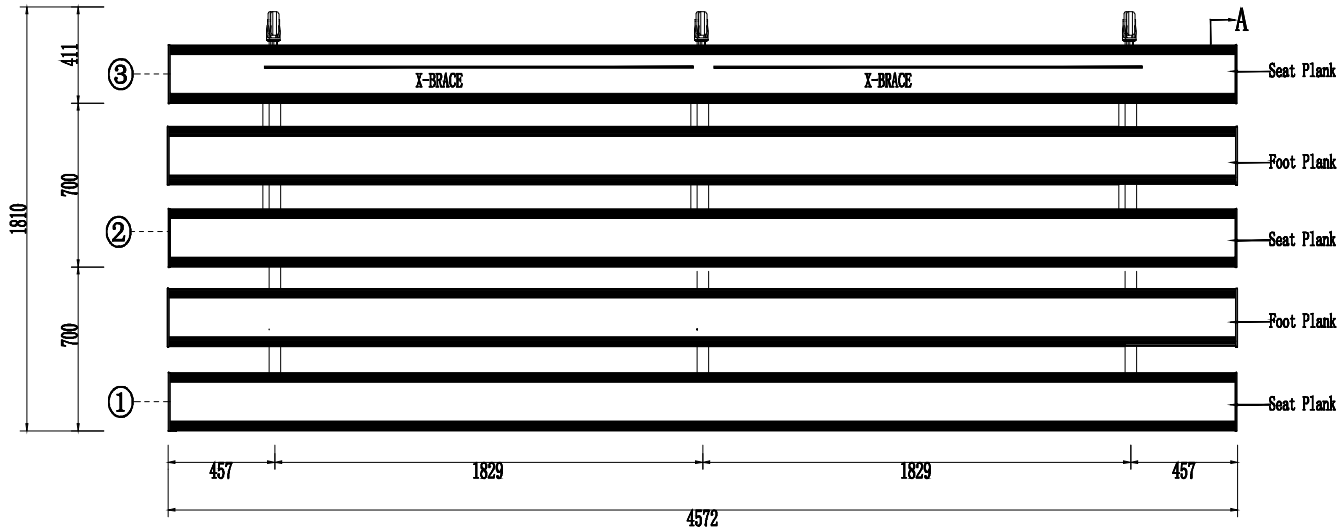

 Mountain bleacher			
SCALE	1:100	ID	3P-W700-F397-S291
DATE	2020/7/27	https://www.mountainbleacher.com	
DESIGN	Mr. Liu	Tel: 008615070297138 / 008618879222225	
CHECK	Mr. Chang	E-mail: dong@mountainbleacher.com	
TITLE			1

UNIT: mm

Size table	S	M	L	XL
Row Spacing	650mm	700mm	750mm	800mm
		↓		

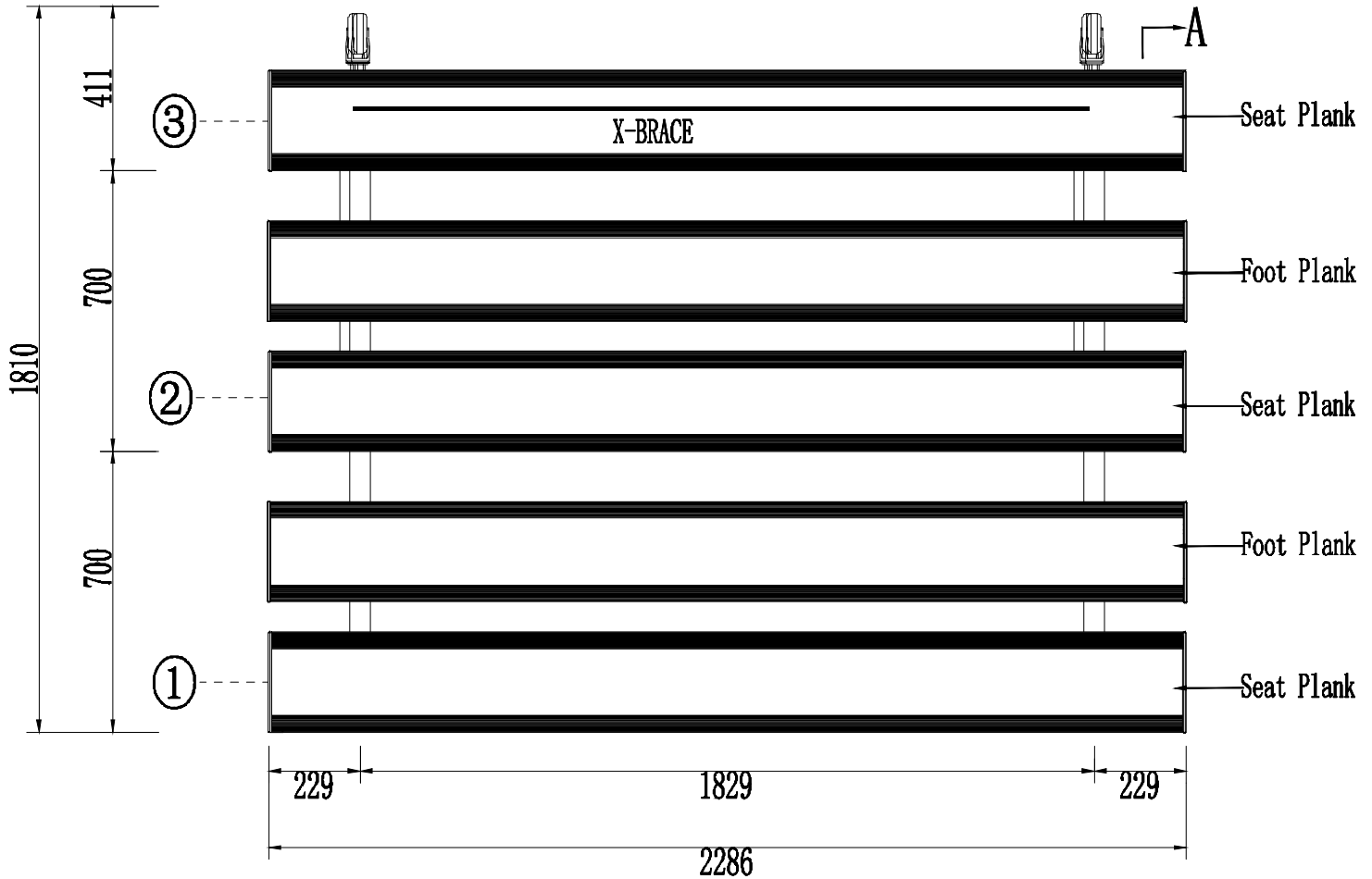

SEATING PLAN

UNIT: mm

 Mountain bleacher			
SCALE	1:100	ID	3P-W700-F397-S291
DATE	2020/1/27	https://www.mountainbleacher.com	
DESIGN	Mr. Len	Tel: 008615070297138 / 00861887922225	
CHECK	Mr. Cheng	E-mail: dorg@mountainbleacher.com	
TITLE		NO.	1

Size table	S	M	L	XL
Row Spacing	650mm	700mm	750mm	800mm
		✓		

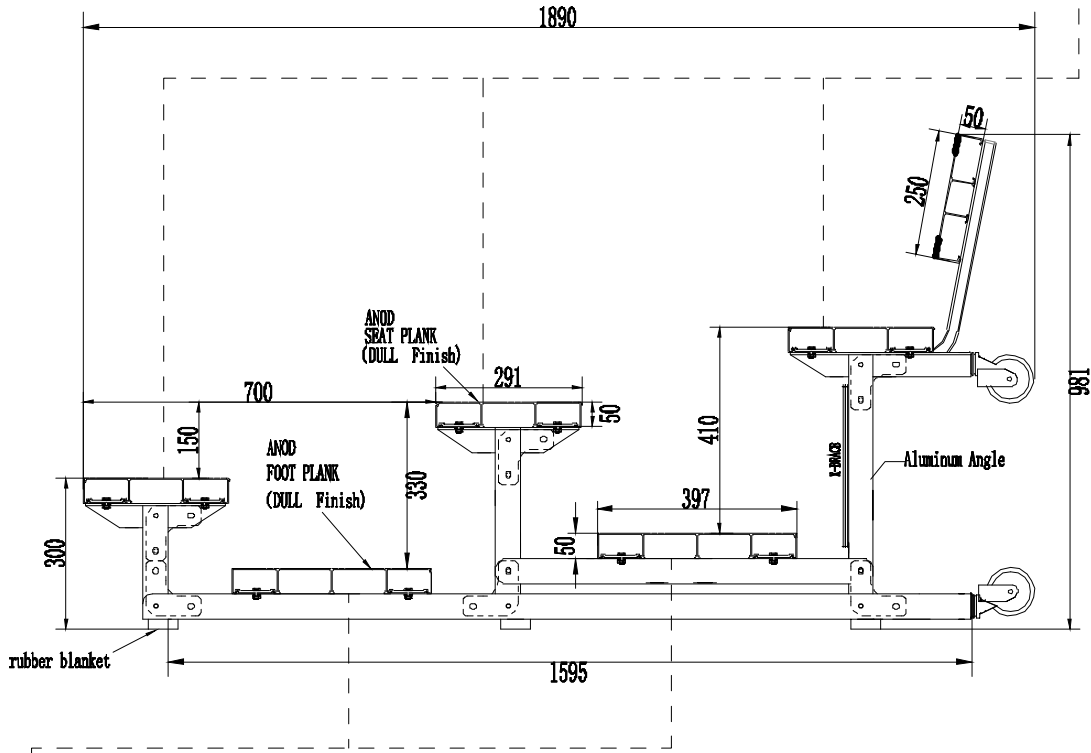

Side view AA

UNIT:mm

Seat model optional

	SEAT PLANK	Live Load	advice	choose
1	300*50*2 Aluminum alloy	2.13kn/m ²	★★★	
2	291*50*2 Aluminum alloy	1.98kn/m ²	★★★★	
3	250*50*2 Aluminum alloy	1.77kn/m ²	★★★★	
4	250*38*2 Aluminum alloy	1.01kn/m ²	No	
5	300*450*100 HDPE	1.76kn/m ²	★★	
6	410*417*175 HDPE	1.76kn/m ²	No	
7	450*410*330 HDPE	1.76kn/m ²	No	

FOOT PLANK	1	2	3	4
	397*50*2 Aluminum alloy	291*50*2 Aluminum alloy	250*50*2 Aluminum alloy	250*38*2 Aluminum alloy
Live Load	2.81 kn/m ²	2.06 kn/m ²	1.77 kn/m ²	1.01 kn/m ²
advice choose	★★	★★★★	★★★★	No



Mountain bleacher

SCALE	1:100	ID	3F-W700-F397-S291-B250
DATE	2020/7/27	URL	https://www.mountainbleacher.com
DESIGN	Mr. Liu	TEL	008618879222226, 008618070297188
CHECK	Mr. Cheng	E-MAIL	dong@mountainbleacher.com
TITLE			1

Size table	S	M	L	XL
Row Spacing	650mm	700mm	750mm	800mm
		4		

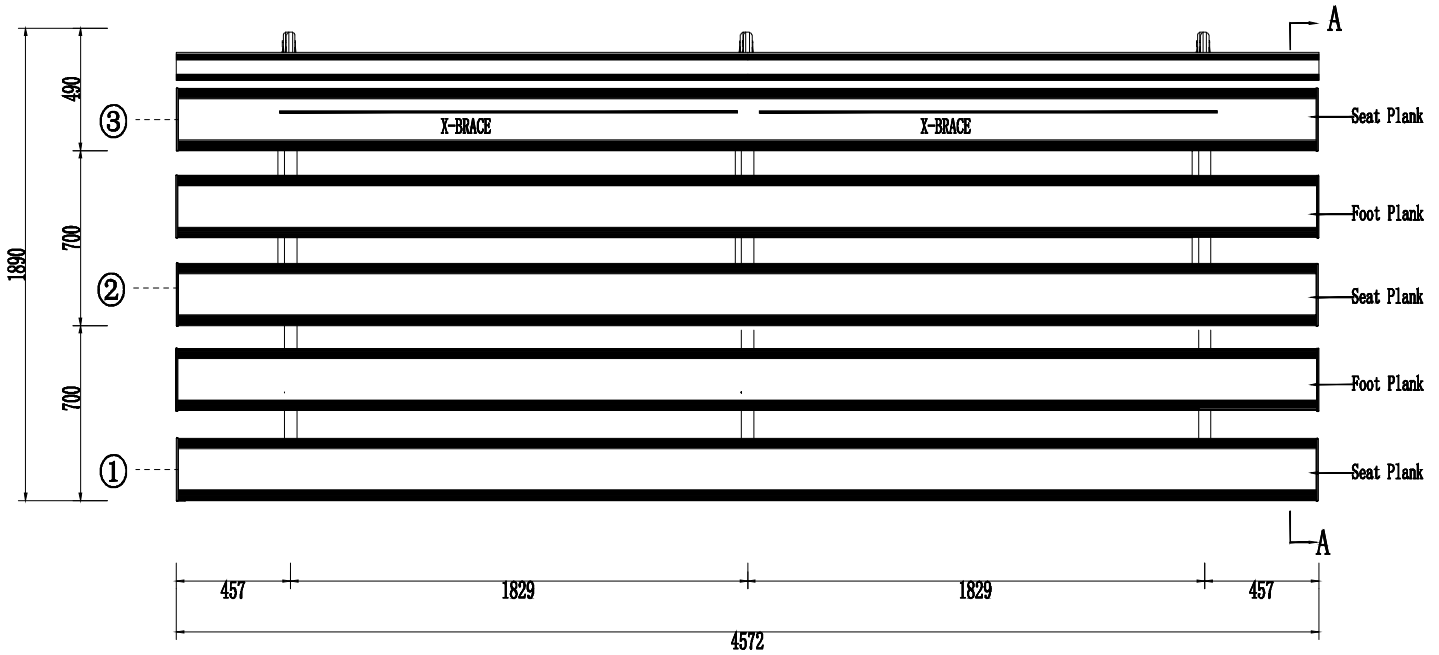

SEATING PLAN

UNIT: mm

 Mountain bleacher			
SCALE	1:100	ID	3P-W700-F397-S291-B250
DATE	2020/7/27	https://www.mountainbleacher.com	
DESIGN	Mr. Liu	Tel: 008615070297138 / 008618879222225	
CHECK	Mr. Cheng	E-mail: dong@mountainbleacher.com	
TITLE		NO.	1

Size table	S	M	L	XL
Row Spacing	650mm	700mm	750mm	800mm
		✓		

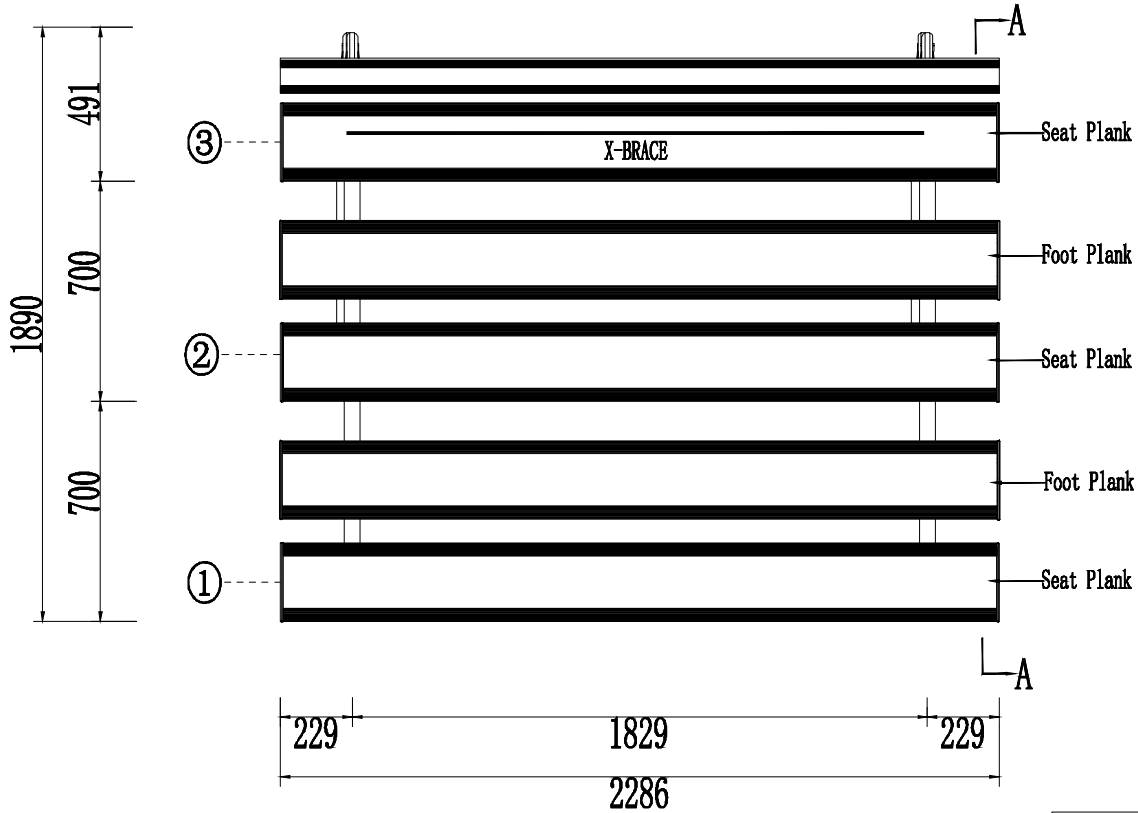

SEATING PLAN

UNIT: mm

 Mountain bleacher			
SCALE	1:100	ID	3F-W700-F397-S291-B250
DATE	2020/7/27	URL	https://www.mountainbleacher.com
DESIGN	Mr. Liu	TEL	Tel: 008615070297138 / 008618879222225
CHECK	Mr. Cuiyong	E-MAIL	E-mail: dong@mountainbleacher.com
TITLE		NO.	1

Size table	S	M	L	XL
Row Spacing	650mm	700mm	750mm	800mm
		✓		

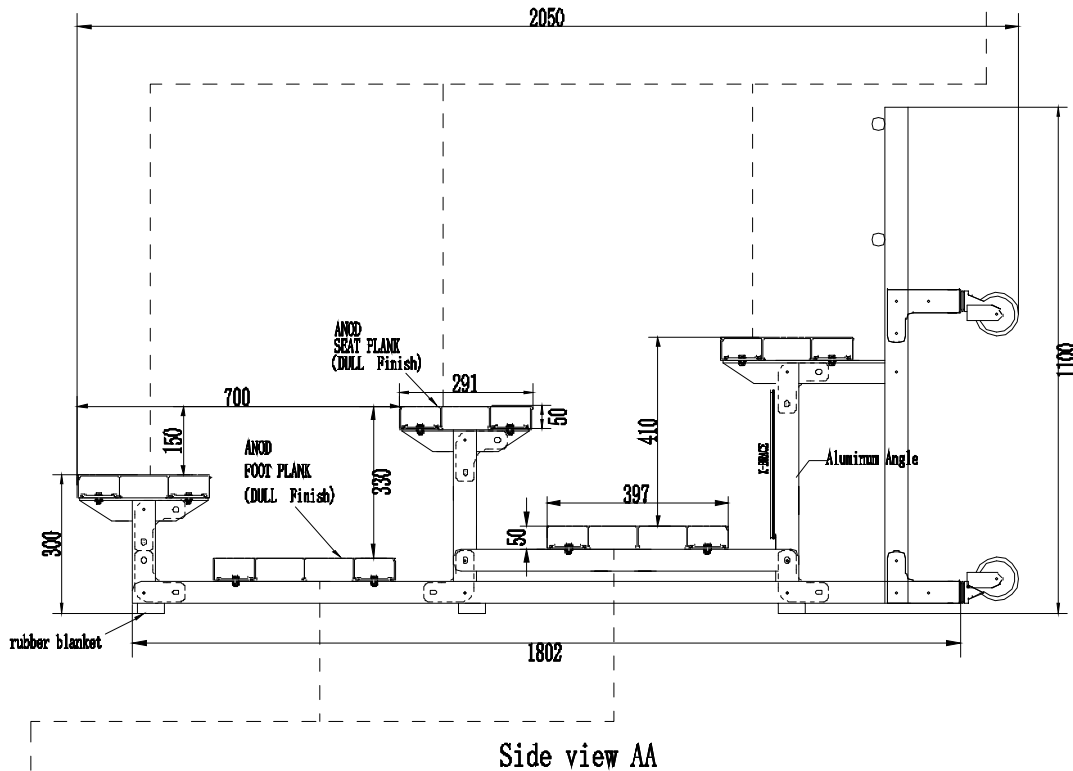

Side view AA

UNIT:mm

Seat model optional

SEAT PLANK		Live Load	advice	choose					
1	300*50*100 Aluminum alloy	2.13kn/m ²	★★★						
2	291*50*2 Aluminum alloy	1.98kn/m ²	★★★★						
3	250*50*2 Aluminum alloy	1.77kn/m ²	★★★★						
4	250*38*2 Aluminum alloy	1.01kn/m ²	No						
5	300*450*100 HDPE	1.76kn/m ²	★★						
6	410*417*175 HDPE	1.76kn/m ²	No						
7	450*410*330 HDPE	1.76kn/m ²	No						
FOOT PLANK									
1	397*50*2 Aluminum alloy	2	291*50*2 Aluminum alloy	3	250*50*2 Aluminum alloy	4	250*38*2 Aluminum alloy		
Live Load		2.81kn/m ²		2.06kn/m ²		1.77kn/m ²		1.01kn/m ²	
advice		★★		★★★★		★★★★		No	

Mountain bleacher

SCALE 1:100 ID 3F-W700-F397-S291-B/T
 DATE 2020/7/27 https://www.mountainbleacher.com
 DESIGN Mr. Liu Tel: 008618879222226, 008615070297138
 DRAW Mr. Chang E-mail: dou@mountainbleacher.com
 TITLE No. 1

Size table	S	M	L	XL
Row Spacing	650mm	700mm	750mm	800mm
		√		

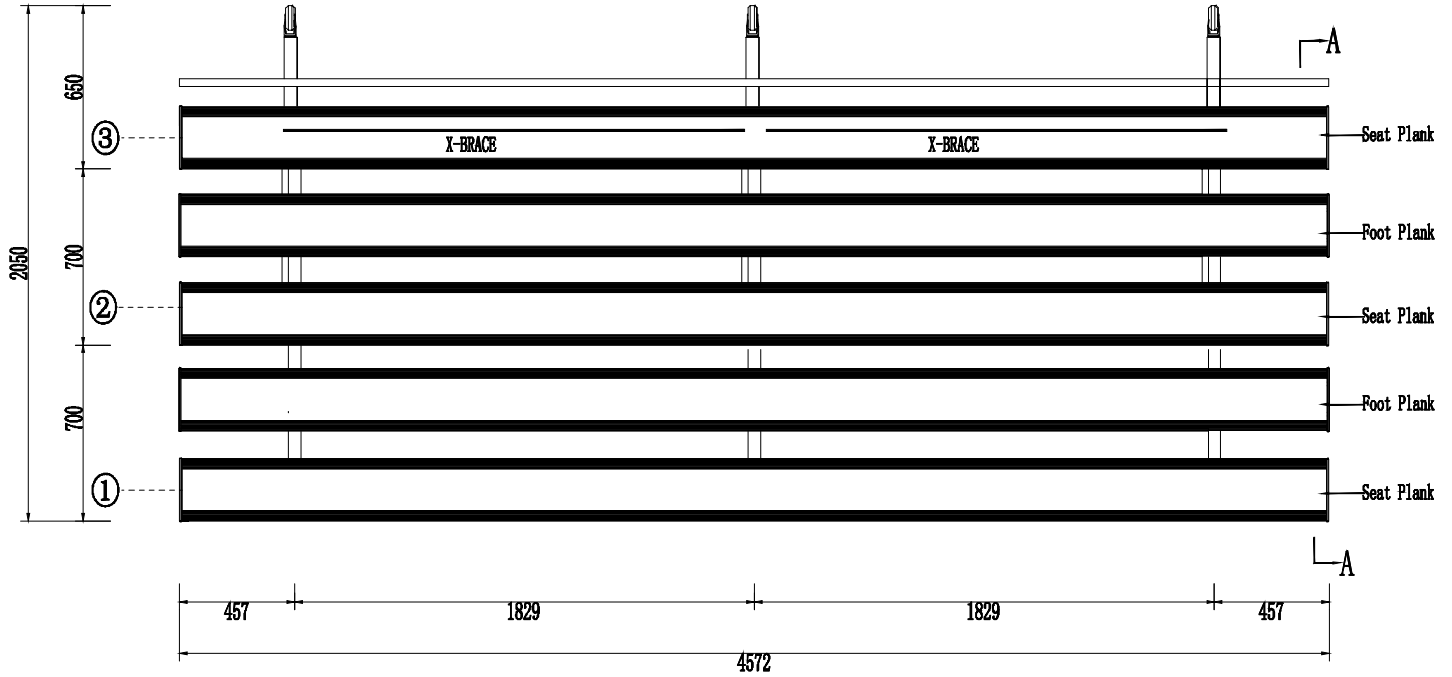

SEATING PLAN

UNIT: mm

 Mountain bleacher			
SCALE	1:100	ID	3F-W700-F397-S291-B/T
DATE	2020/1/27	https://www.mountainbleacher.com	
DESIGN	Mr. Lau	Tel: 008615070297138 / 008618879222226	
CHECK	Mr. Cheung	E-mail: dong@mountainbleacher.com	
TITLE		NO.	1

Size table	S	M	L	XL
Row Spacing	650mm	700mm	750mm	800mm
		√		

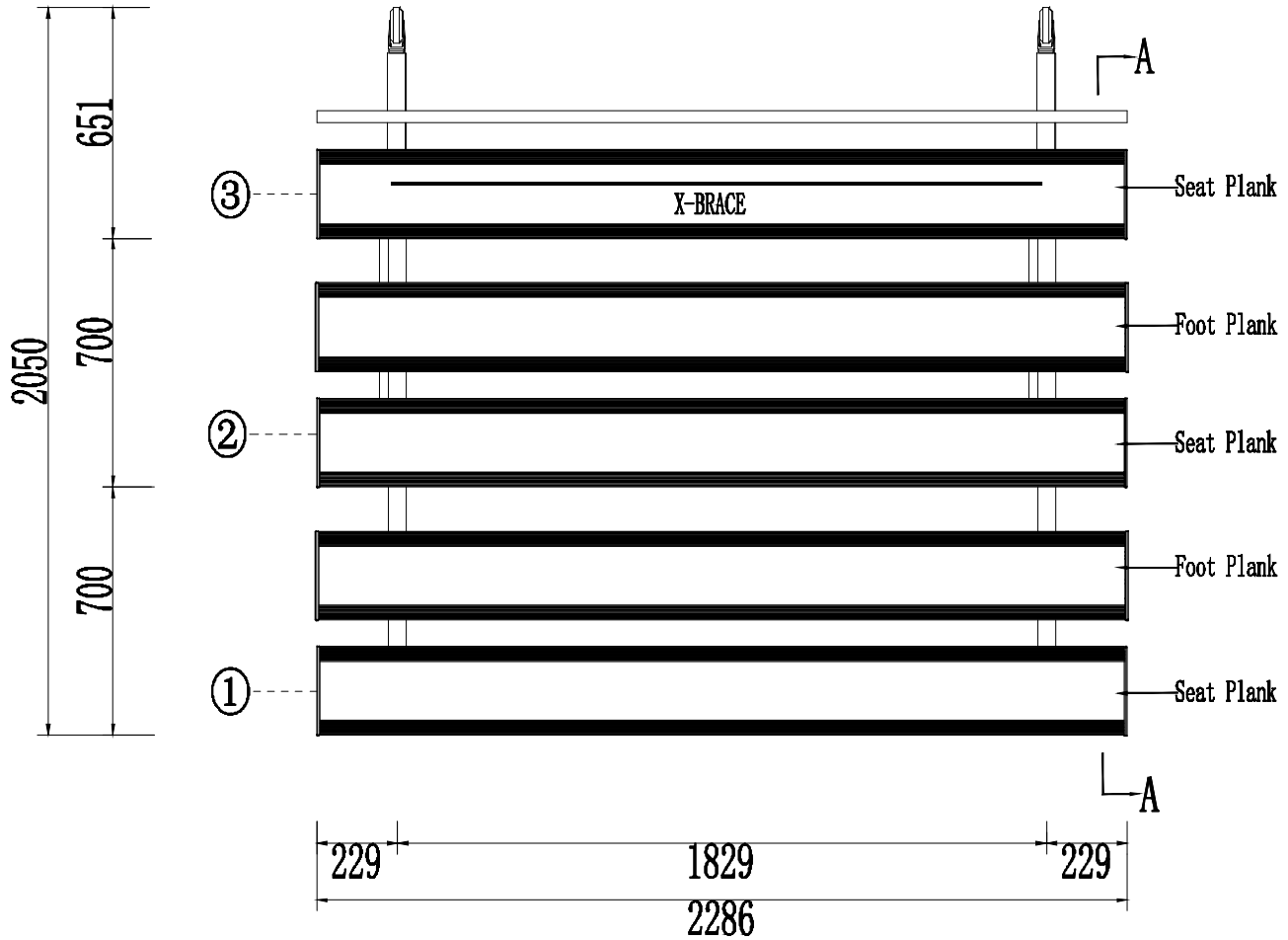

SEATING PLAN

UNIT: mm

		Mountain bleacher	
SCALE	1:100	ID	3P-W700-F397-5291-B/T
DATE	2020/1/27	https://www.mountainbleacher.com	
DESIGN	Mr. Lau	PHONE	Tel: 008615070297138 / 008618879222225
CHECK	Mr. Cheung	E-mail	dong@mountainbleacher.com
TITLE			